

**Operant and classical learning in *Drosophila melanogaster*:  
the *ignorant* gene (*ign*)**



Dissertation zur Erlangung des  
naturwissenschaftlichen Doktorgrades  
der Bayerischen Julius-Maximilians-Universität Würzburg

vorgelegt von

Franco Bertolucci  
aus Vicenza

Würzburg, 2008

Eingereicht am: .....

Mitglieder der Promotionskommission:

Vorsitzender: .....

Gutachter: Prof. Dr. Martin Heisenberg

Gutachter: Prof. Dr. Wolfgang Rössler

Tag des Promotionskolloquiums: .....

Doktorurkunde ausgehändigt am: .....

**Erklärung gemäß § 4 Absatz 3 der Promotionsordnung der Fakultät für Biologie der Bayerischen Julius-Maximilians-Universität zu Würzburg vom 15. März 1999:**

Hiermit erkläre ich die vorgelegte Dissertation selbständig angefertigt zu haben und keine anderen als die von mir angegebenen Quellen und Hilfsmittel verwendet zu haben. Die mit meinen Publikationen (siehe list of publications) wortgleichen oder nahezu wortgleichen Textpassagen habe ich selbst verfasst. Alle aus der Literatur genommenen Stellen sind als solche kenntlich gemacht.

Des Weiteren erkläre ich, dass die vorliegende Arbeit weder in gleicher noch in ähnlicher Form bereits in einem anderen Prüfungsverfahren vorgelegen hat. Zuvor habe ich keine akademischen Grade erworben oder zu erwerben versucht.

Würzburg, den

Franco Bertolucci

Prof. Martin Heisenberg

# INDEX

<b>1</b>	<b>INTRODUCTION</b>	<b>7</b>
1.1	CLASSICAL CONDITIONING	7
1.2	OPERANT CONDITIONING	9
1.3	BIOCHEMICAL PATHWAYS IN LEARNING AND MEMORY FORMATION	11
1.3.1	RIBOSOMAL S6 KINASES	11
1.3.2	THE MAPK/ERK PATHWAY	14
1.3.3	ROLE OF MAPK/ERK KINASE SIGNALING IN LEARNING AND MEMORY	15
1.3.4	LEARNING AND MEMORY SIGNALING CASCADE IN <i>DROSOPHILA</i>	16
1.4	MORPHOLOGICAL APPROACH TO LEARNING AND MEMORY ANALYSIS	20
1.4.1	THE MUSHROOM BODIES	20
1.4.2	THE GAL4-UAS SYSTEM	21
1.5	LEARNED HELPLESSNESS	23
1.5.1	SEX DIFFERENCES IN LEARNED HELPLESSNESS	24
1.5.2	LEARNED HELPLESSNESS AND SEROTONIN	25
1.6	AIM OF THIS STUDY	25
<b>2</b>	<b>MATERIALS AND METHODS</b>	<b>27</b>
2.1	FLIES	27
2.1.1	FLY CARE	27
2.1.2	GENOTYPES	27
2.1.3	FLY STRAINS	27
2.1.4	<i>DROSOPHILA</i> CROSSES	29
2.2	BEHAVIORAL PARADIGMS	31
2.2.1	THE OLFACTORY REVOLVER DEVICE	31
2.2.1.1	ELECTRIC SHOCK SENSITIVITY TEST	32
2.2.1.2	ODORANT ACUITY TEST	33
2.2.1.3	CLASSICAL CONDITIONING EXPERIMENT	33
2.2.2	THE HEAT BOX	35
2.2.2.1	STANDARD EXPERIMENT	36
2.2.2.2	IDLE EXPERIMENT	37
2.2.2.3	THERMOSENSITIVITY ASSAY	38
2.2.3	STATISTICAL METHODS	38

2.2.4	PHARMACOLOGICAL TREATMENT OF FLIES	39
2.2.5	MOLECULAR TECHNIQUES	39
2.2.5.1	SINGLE FLY PCR	40
<b>3</b>	<b>RESULTS</b>	<b>41</b>
<b>3.1</b>	<b>OLFACTORY CONDITIONING IN S6KII MUTANTS</b>	<b>41</b>
3.1.1	CHARACTERIZATION OF TRANSGENIC LINES	41
3.1.2	GENOMIC RESCUE OF <i>S6KII</i> IN OLFACTORY CONDITIONING	43
3.1.3	HETEROZYGOUS <i>S6KII</i> MUTANTS IN OLFACTORY CONDITIONING	44
3.1.4	OVEREXPRESSING TRANSGENIC LINES IN OLFACTORY CONDITIONING	44
3.1.5	RESCUE VIA TEMPORAL EXPRESSION OF S6KII	45
3.1.6	LOCAL RESCUE OF <i>S6KII</i> IN OLFACTORY CONDITIONING	46
3.1.7	<i>RUTABAGA-IGNORANT</i> DOUBLE MUTANTS IN OLFACTORY CONDITIONING	50
3.1.8	RNAi MEDIATED <i>S6KII</i> EXPRESSION SILENCING IN OLFACTORY CONDITIONING	51
3.1.9	ODOR INTENSITY LEARNING IN OLFACTORY CONDITIONING MUTANTS	52
<b>3.2</b>	<b>S6KII MUTANTS IN THE HEAT-BOX</b>	<b>53</b>
3.2.1	TRANSGENIC FLIES IN THE HEAT-BOX	54
3.2.2	RESCUE OF THE PHENOTYPE IN THE HEAT-BOX	55
3.2.3	EFFECTS OF LOCAL OVEREXPRESSION OF <i>S6KII</i> IN OPERANT CONDITIONING	56
3.2.4	DOUBLE MUTANT <i>RUT, 58-1</i> IN THE HEAT-BOX	57
3.2.5	EFFECT OF COLD SHOCK ON PLACE CONDITIONING IN THE HEAT-BOX	58
<b>3.3</b>	<b>THE “IDLE” EXPERIMENT, A NOVEL ASSAY FOR THE HEAT-BOX</b>	<b>59</b>
<b>3.4</b>	<b>LEARNED HELPLESSNESS</b>	<b>63</b>
3.4.1	LEARNED HELPLESSNESS IN THE HEAT-BOX	63
3.4.2	EFFECT OF ANTIDEPRESSANTS ON LEARNED HELPLESSNESS IN THE HEAT-BOX	65
<b>4</b>	<b>DISCUSSION</b>	<b>69</b>
<b>4.1</b>	<b>CHARACTERIZATION OF MEMORIES IN S6KII MUTANTS</b>	<b>69</b>
4.1.1	OLFACTORY CONDITIONING	69
4.1.2	PLACE CONDITIONING	73
<b>4.2</b>	<b>THE “IDLE EXPERIMENT”</b>	<b>75</b>
<b>4.3</b>	<b>LEARNED HELPLESSNESS</b>	<b>75</b>
<b>5</b>	<b>LIST OF ABBREVIATIONS</b>	<b>77</b>
<b>6</b>	<b>TABLE OF FIGURES</b>	<b>78</b>

<b><u>7</u></b>	<b><u>SUMMARY / ZUSAMMENFASSUNG</u></b>	<b><u>79</u></b>
<b><u>8</u></b>	<b><u>REFERENCES</u></b>	<b><u>83</u></b>
<b><u>9</u></b>	<b><u>CURRICULUM VITAE</u></b>	<b><u>101</u></b>
<b><u>10</u></b>	<b><u>ACKNOWLEDGEMENTS</u></b>	<b><u>102</u></b>

# 1 Introduction

*Drosophila* represents in Genetics an attractive model for dissecting the molecular mechanisms of behavioral plasticity. At the cellular level, *Drosophila* has contributed a wealth of information on the system's plasticity (Margulies et al., 2005). Until recently, however, these studies have relied on the conceptual basis that the two forms of associative learning, operant and classical conditioning, rely on diverse signaling pathways although in contrast to non associative learning, they both require close temporal contiguity of stimuli events to form (Lukowiak et al., 1996).

The main difference between classical and operant conditioning is that in the first case a contingency is formed between a stimulus and a reinforcer (Kreidl, 1895; Pavlov, 1927) while in the second case a contingency is formed between a response and a reinforcer (Skinner, 1950). In nature it might be hard to discern between the two forms of learning, due to a feedback loop between the behavior of the organism and the environment. For instance a bird looking for food may come across a colorful insect and display the common preying behavior ingurgitating the insect, only to realize that the insect is toxic and therefore expelling it. The bird will avoid similar insects in the future, as a consequence of the pavlovian association between the external pattern of the insect and its toxicity, but it is also disputable that the act of capturing and swallowing the prey could reveal an operant component of the associative process. Later studies dismissed the operant-classical feedback loop revealing that the behavior of the animal is not relevant to the learning process and that the basic components of the learning process in the brain consist of the two environmental events, the conditioned stimulus CS and the predicted unconditioned stimulus US (Mozzachiodi et al., 2003; Nader, 2003). A similar point of convergence between operant conditioning and the unconditioned stimulus (in the operant classification also named reinforcer) has been reported in *Aplysia* (Brembs et al., 2002). At the molecular level the key elements which distinguish classical from operant conditioning are mostly unknown.

## 1.1 Classical Conditioning

Classical conditioning can also be described as the ability to associate a predictive stimulus with a subsequent salient event. This was first documented in the 19<sup>th</sup> century by a scientist working at the Physiological institute of the University of Vienna, Alois Kreidl, who

described the ability of fishes to associate a tone with food. The phenomenon was later investigated on a larger scale and more deeply by Ivan Petrovich Pavlov (Logan, 2002). He trained dogs to associate a tone with a food reward by pairing the two stimuli (Pavlov, 1927), a gustatory stimulus (food, the unconditioned stimulus, US) - and an auditory (bell) or visual stimulus - the conditioned stimulus (CS). The US elicits the unconditioned response: (UR) the dogs salivate. After the pairing the CS comes to evoke a conditioned response (CR), which is similar to the unconditioned response (UR) elicited by the US. By his research, Pavlov significantly influenced not only science, but also popular culture and since then classical conditioning is often referred to as Pavlovian conditioning.

Cellular and molecular processes underlying classical conditioning are studied in *Aplysia*, a slug-like marine mollusk, and it appears that the US is “replaced” by the CS during training: simultaneous stimulation of the sensory neuron receiving the CS+ (SN<sub>1</sub>) and the sensory neuron receiving the US (reinforcer) facilitates synaptic efficacy of the SN<sub>1</sub> presynaptically. As depicted in Figure 1-1, after some conditioning trials, stimulation of the SN<sub>1</sub> alone elicits the reflexive behavior; the UR eliciting properties of the reinforcer have been transferred to the SN<sub>1</sub> (Lechner and Byrne, 1998).

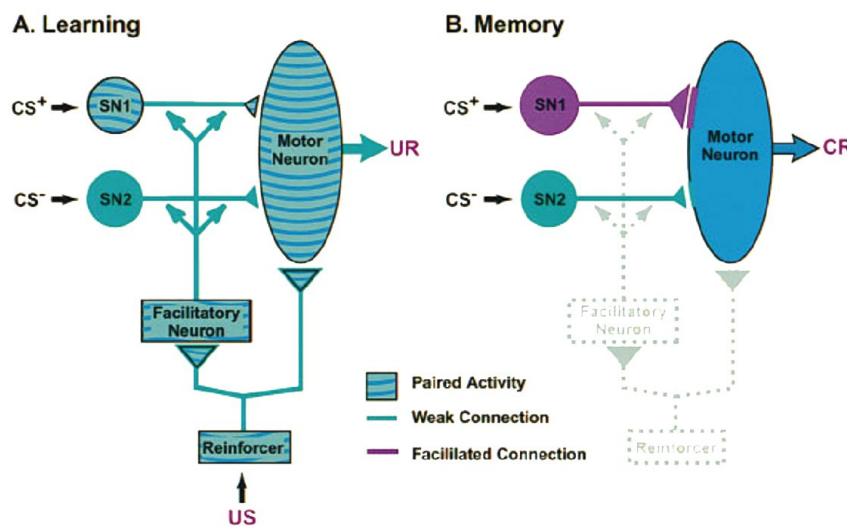

**Figure 1-1: General scheme of associative facilitation**

**(A) Learning.** Activity in one sensory neuron (SN1) is paired (CS<sup>+</sup>) with the reinforcing stimulus (US). Activity in SN2 is unpaired (CS<sup>-</sup>) with the US. The US itself acts by activating the motor neuron directly, thus producing the unconditioned response (UR), and by activating a modulatory system (facilitatory neuron) that nonspecifically enhances the synaptic strength of both sensory neurons. This non-associative facilitation is

thought to contribute to sensitization in the behaving animal. The paired activity in SN1 results in a selective amplification of the facilitation caused by the US. **(B) Memory.** As a result of paired activity, the synaptic strength in the SN1 is enhanced, which increases its probability to activate the motor neuron and to produce the conditioned response (CR). Because activity in SN2 was unpaired with the US, the connection of SN2 is not specifically enhanced (figure modified from Lechner and Byrne, 1998).

With its ca. 200.000 neurons *Drosophila melanogaster* represents a relatively simple system to study behavioral plasticity. Despite this small number, *Drosophila* is capable of complex behaviors which can be used as models in neuroscience. In fact, several paradigms have been developed to study different behaviors in associative learning and memory, such as



courtship conditioning or the flight simulator (Tully, 1984; Dudai, 1988; Dill et al., 1995; Greenspan and Ferveur, 2000). The most comprehensively studied experimental pavlovian memory task is olfactory learning (Quinn et al., 1974; Waddell and Quinn, 2001). This experiment is performed in a modified version (Schwaerzel et al., 2003) of a device known as the “Tully machine” (Tully and Quinn, 1985). The training consists of two olfactory cues (CS+ and CS-), which are sequentially presented to the animals, the first accompanied by the US (CS+), the second without the US (CS-). In a subsequent test trial, the animals must choose between the two olfactory cues (CS+ vs. CS-) in a forced choice maze (for more details see Material and Methods).

## **1.2 Operant Conditioning**

Edward Lee Thorndike studied operant conditioning already at the end of the 19<sup>th</sup> century by analyzing the behavior of cats in trial-and-error experiments involving puzzle boxes (Thorndike, 1898). After him the interest of experimental researchers on the aspects of this kind of associative learning grew and many other organisms were used to understand the mechanism underlying what later will be also referred to as instrumental conditioning. For instance, Burrhus Frederic Skinner developed an operant learning chamber (named the Skinner box) for small animals like rodents or pigeons which allowed the investigation of the rate of a behavior as a dependent variable in a controlled experimental environment and also to introduce the concept of reinforcer: a stimulus, such as a reward, the removal of an unpleasant event, or a punishment, that in operant conditioning maintains or strengthens a desired behavior (Skinner, 1950).

By now a vast range of model organisms has been used to study operant conditioning mostly vertebrates like rats, mice, pigeons and various primates (Verplanck, 1956; Berger, 1968; Peter et al., 2002), but also mollusks such as *Aplysia* or arthropods like crabs, crickets and honeybees (Erber, 1976; Abramson and Feinman, 1987; Jaffe et al., 1990).

Many years study on *Drosophila melanogaster* has contributed to learning and memory research, not only in classical conditioning experiments as previously mentioned, but also in operant conditioning. In fact the fruit fly is known to be able to solve instrumental tasks like lifting their legs to avoid electric shock in a modification of the Horridge leg paradigm (Booker and Quinn, 1981). More recently, operant learning was successfully tested via a torque-meter where tethered *Drosophila* flies used visual motion, heat or odor as external

stimuli to gain information from the outside and yaw torque, thrust or direction of flight in various combinations. The experimental setup utilized in these experiments is called flight simulator (Wolf and Heisenberg, 1991). It is an instrument of key importance for exploring genetic components and locate neuronal structures which control learning and memory (Dill et al., 1995; Brembs and Heisenberg, 2000).

As an alternative to the flight simulator the “heat-box” was developed. This paradigm has the advantage that it allows to test simultaneously many freely walking flies for operant conditioning (Wustmann et al., 1996). In this machine individual animals are trained to avoid one half of a small test chamber. Their position in the chamber is continuously monitored. Whenever they enter the “forbidden” side, the chamber is heated, establishing in the fly a spatial preference. In a subsequent memory test without heat punishment, the flies continue to avoid the side previously associated with heat. A performance index is calculated by subtracting the time spent on the “punished” side from the time spent on the “unpunished” side and dividing by the total time. The cues that help the fly in its orientation in the chamber are temperature and tactile information in combination with idiothetic path integration (Mittelstaedt and Mittelstaedt, 1973).

The heat-box was used to test mushroom body-less flies for operant conditioning and it showed that flies with chemically ablated mushroom bodies were performing as well as normal flies (Wolf et al., 1998). Mutants known to be impaired in learning and memory like *rutabaga* (*rut*), *amnesiac* (*amn*) and *dunce* (*dnc*) were also tested and showed reduced performance in operant conditioning (Wustmann et al., 1996). Moreover, mutants for *rut* were used to map the structures in the central nervous system requiring normal *rut* adenylate cyclase for heat-box learning. The results showed that the candidate neuropils were the antennal lobes, the median bundle and the ventral ganglion. On the contrary structures like the mushroom bodies or the central complex do not require *rut* for heat-box learning (Zars et al., 2000).

As it emerges from the previous paragraphs, the Tully machine, the torque-meter and the heat-box are important tools for the understanding of classical and operant conditioning. Although both conditioning processes are conceptually separable, there has been considerable debate whether, at some basic level, they are also mechanistically distinct (Rescorla and

Solomon, 1967) or similar (Gormezano and Tait, 1976). At the molecular level it is still unclear which pathways are shared and which not.

In search for genes in *Drosophila melanogaster* that would differentially affect the two conditioning processes, the gene S6KII has been isolated (Putz, 2002). This gene encoding the ribosomal S6 kinase II serves different functions in operant place learning (Putz, 2002) and classical olfactory conditioning (Bertolucci, 2002). Many questions about how this protein affects these two types of associative learning are still open and the biochemical and behavioral tests performed in this thesis are an attempt to answer some of these questions.

### **1.3 Biochemical pathways in learning and memory formation**

#### **1.3.1 Ribosomal S6 Kinases**

Ribosomal S6 kinases [RSKs; also known as p90<sup>rsk</sup>, S6KI and S6KII, or mitogen-activated protein kinase (MAPK)-activated protein kinase-1] are a family of serine–threonine kinases that become activated by and are mediators of the Ras–extracellular signal-regulated kinase (ERK) signaling pathway (Frodin and Gammeltoft, 1999). The first RSK was identified in *Xenopus laevis* in 1985 (Erikson and Maller, 1985). Four RSK isoforms (RSK1–4) are known in vertebrates, whereas in *Drosophila* only a single isoform has been described that encodes a serine/threonine kinase of 910aa. The gene was isolated from an eye-antennal imaginal disk library and subsequently sequenced (Wassarman et al., 1994). Sequence comparison of the translated ORF using the BLAST network service (Altschul et al., 1990) yields the highest scores in comparison with vertebrate S6KII proteins. Mouse, chicken and *Xenopus* S6KII proteins (Jones et al., 1988; Alcorta et al., 1989) have identity values of 60%, 60% and 63%, and similarity values of 74%, 75% and 77%, respectively, when compared to the predicted 90-kDa protein. RSKs are characterized by two kinase domains. The C-terminal kinase domain, which extends from aa 195 to 460, belongs to the CamK family and contributes through autophosphorylation to full activation of the N-terminal kinase domain (aa 560 to 840), which belongs to the AGC kinase family and phosphorylates substrates such as the cAMP response element –binding protein (CREB), c-Fos, NFκB (nuclear factor κB), IκBα (inhibitor of nuclear factor-κB) and fundamentally recognizes the basophilic consensus motif Arg/Lys-X-Arg-X-X-Ser/Thr or Arg-Arg-X-Ser/Thr (Leighton et al., 1995).

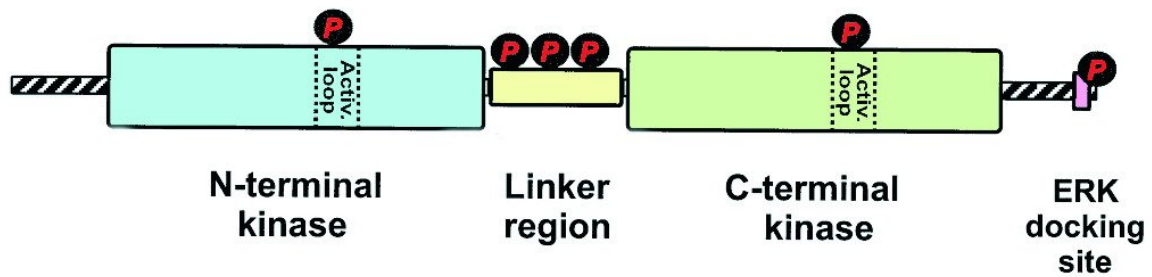

**Figure 1-2: Functional domains and phosphorylation sites of RSK.**

Four functional domains are conserved in all isoforms of RSK: The N-terminal kinase, the linker region, the C-terminal kinase and the ERK-docking site. The N- and C-terminal tails show highest sequence variation among the RSK isoforms (figure modified from Frodin and Gammeltoft, 1999).

RSKs can be required for several different functions: they are important components in cell cycle progression, cell survival and cytostatic-factor arrest. Additional tasks include the feedback inhibition of the Ras-ERK pathway by phosphorylation of the Ras GTP/GDP-exchange factor Sos and the regulation of protein synthesis by phosphorylation of polyribosomal proteins and glycogen synthase kinase-3 (Douville and Downward, 1997; Angenstein et al., 1998). As the activity of RSKs tightly correlates with that of ERK, RSKs have been thoroughly studied as critical downstream effectors of ERK. Indeed, various physiologically important molecules such as lamin-C, glycogen synthase kinase 3, cAMP-responsive binding-element protein (CREB), histone 3B, anaphase-promoting complex (APC), C/EBP beta, Bub1, c-Fos, filamin A, and tuberous sclerosis complex (TSC) were suggested as putative targets mediating the molecular function of RSKs (Frodin and Gammeltoft, 1999; Schwab et al., 2001; Roux et al., 2003).

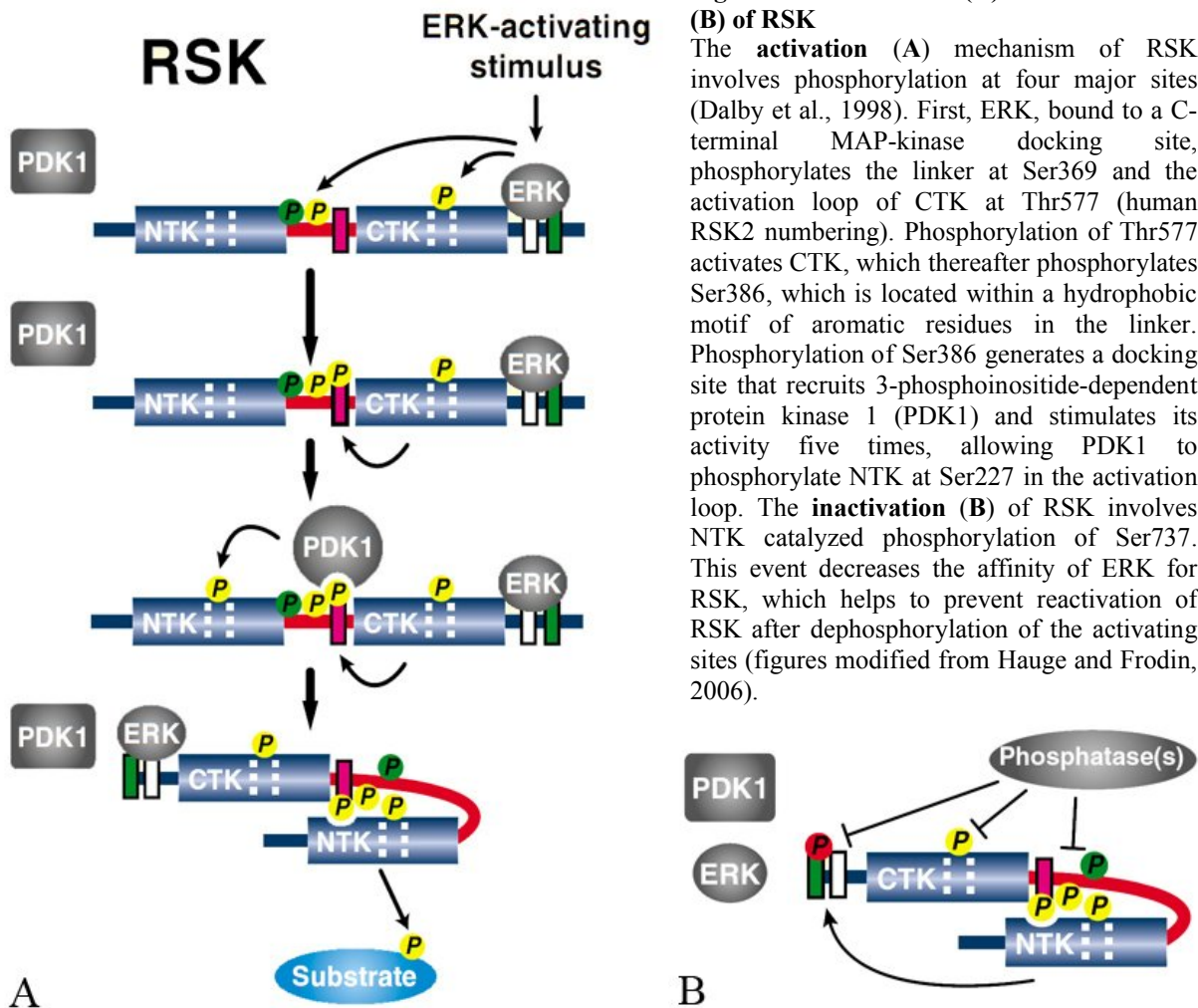

Besides the RSKs another class of S6 Kinases is involved in phosphorylation of S6 in 40S ribosomal subunits was observed: the p70 S6 kinases. The main difference between p70 S6 kinases and p90 ribosomal S6 kinases is that the first display only one kinase domain, the N-terminal kinase domain, beside that the p70 S6 kinases phosphorylate S6 *in vivo* while the p90 S6 kinases appear to phosphorylate S6 only *in vitro* (Erikson, 1991).

The *Drosophila* p90 ribosomal S6 kinase is thought to play an important role in the ERK/MAPK cascade and there are strong hints that it may be involved in memory formation in associative learning. In a classical conditioning paradigm the null mutant displayed a decreased memory score 3 min, 30 min and 3 h after the training session while a P-element insertion line showed a tendency for a decreased performance but was not significantly different from control flies. The precise jump-out line showed a retention level identical to that of the wildtype (Bertolucci, 2002). These results point to an involvement of S6KII in learning and short and middle-term memory formation. Impairment in long-term memory

could not be demonstrated neither after spaced nor massed training, due to large fluctuation in the test scores although the performance of the null mutant and of the p-element insertion lines after one day tended to replicate the trend of the short and middle term memory assays. The similarity of the phenotype to that of *leonardo* mutants (Skoulakis and Davis, 1996), a gene encoding a 14-3-3 protein associated with MAPK signaling, suggests that the defect in olfactory memory of the null mutant could also originate via MAPK signaling. Immunological detection of p90 ribosomal S6 kinase confirmed the hypothesis of absence or a decreased level of the kinase in the null mutant, in accordance with the behavioral results (Bertolucci, 2002).

### 1.3.2 The MAPK/ERK pathway

An important role in the MAPK/ERK signaling cascade is played by the p90 ribosomal S6 kinase; key components for these networks are second messengers, protein kinases and the subcellular distribution of these transducers to bring them into contact with appropriate targets. Within the repertoire of signaling molecules in the network is a family of protein kinase cascades known as mitogen-activated protein (MAP) kinase modules (Figure 1-4). These cascades contain at least three protein kinases in series that culminate in the activation of a multifunctional MAP kinase. MAP kinases are major components of pathways controlling embryogenesis, cell differentiation, cell proliferation, and cell death (Chang and Karin, 2001; Adams and Sweatt, 2002; Orton et al., 2005).

It is activated by the last of the three MAPK kinases, ERK, by phosphorylation on serine/threonine residues and by PKA on the linker region which increases its phosphorylating function (Houslay, 2006). The activated form of RSK translocates from the cytoplasm to the nucleus where it phosphorylates a broad range of substrates like CREB, Jun/Fos and the transcription factor ER( $\alpha$ ) (Richards et al., 2001; Servillo et al., 2002; Mackeigan et al., 2005; Murphy and Blenis, 2006).

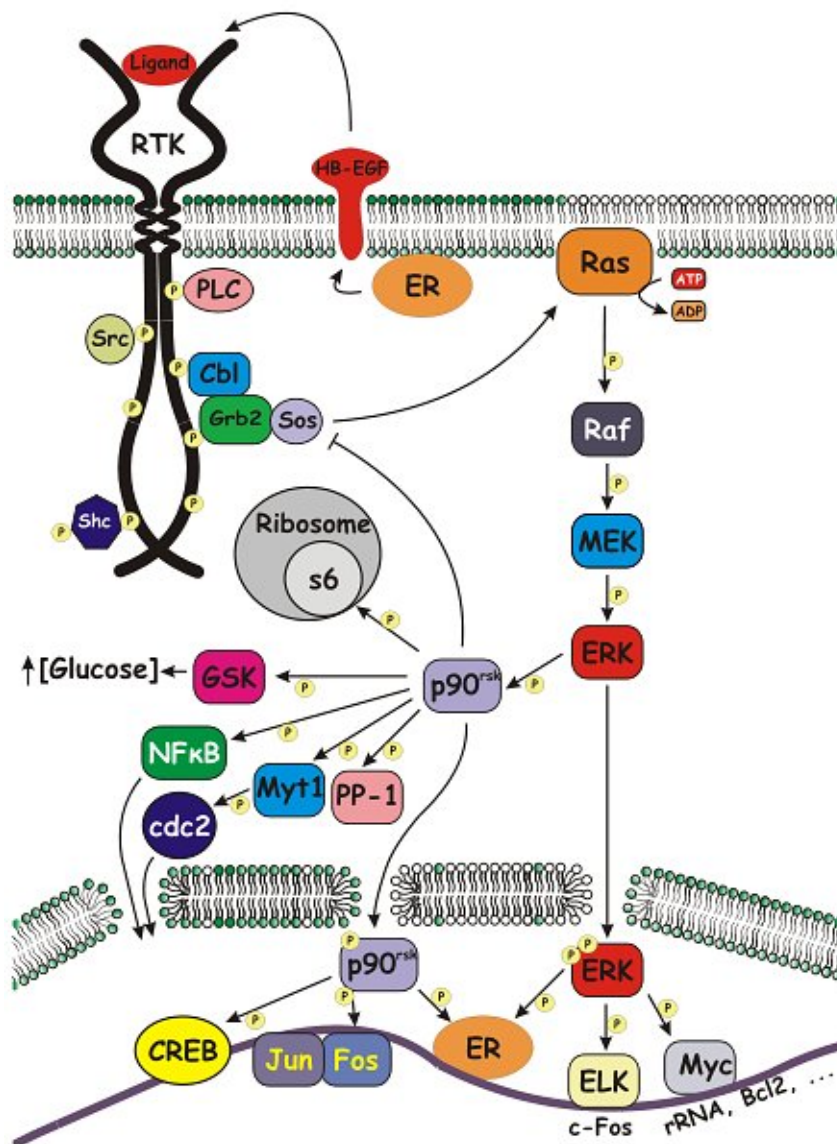

**Figure 1-4: The MAPK/ERK pathway.**

Diagram showing the role of RSK in the MAPK/ERK pathway. Excitatory neurotransmitters bind to a synaptic bouton which starts the chain activating the Ras Family G protein. It prosecutes in a chain of phosphorylations which involves RAF, MEK and ERK. After being activated by ERK, P90 RSK plays an important role in the pathway by phosphorylating CREB in addition to many other targets like Sos, S6 ribosomal protein, GSK, NFκB, Myt1, Histone H3, PP-1, Jun/Fos and ER (figure by Joe Dunckley, UWE - Bristol). Not shown in the graph, PKA phosphorylation of p90 ribosomal S6 Kinase enhances its kinase activity.

### 1.3.3 Role of MAPK/ERK kinase signaling in learning and memory

Regardless of the substantial effort spent to elucidate their components, the biochemical processes involved in activity-dependent synaptic changes are still far from being fully understood. By interfering either pharmacologically or genetically with various signaling molecules, several protein kinase cascades, which involve protein kinase A and C (PKA and PKC), tyrosine kinases of the Src family and the Ca<sup>2+</sup>/calmodulin-dependent kinases (mainly CamKII and CamKIV), have been implicated in the process of long-term memory formation (Chen and Tonegawa, 1997). Current researches suggest that the ERK/MAPK signaling pathway may play a pivotal role in modulating synaptic functions. Consequently, in addition to the well-described ability to tightly control cell growth, this cascade appears to be an important regulator of memory consolidation and long-term neuronal

plasticity. There are many signs which support this view: some components of the signalling pathway, such as Ras itself, ERK1/2 MAPKs and Ras regulators such as RasGRF, SynGAP and NF1, are highly expressed in the adult central nervous system (CNS), in particular in associational areas implicated in learning and memory, i.e. the hippocampus, the neocortex and the cerebellum (Impey et al., 1999). Furthermore synaptic activation in neuronal cultures or in slices, causing elevation of intracellular cAMP and calcium, also potently activates MAPK signaling through Ras signaling (Mazzucchelli and Brambilla, 2000). The Ras subfamily of small GTP-binding proteins plays an essential role in a variety of cellular events, including normal and malignant proliferation, differentiation and survival (Finkbeiner and Greenberg, 1996). A detailed description of the biochemistry of Ras signaling can be found in recent reviews (Grewal et al., 1999; Impey et al., 1999). In neuronal cells, activation of the Ras pathway is mediated by a variety of receptor systems, including receptor tyrosine kinases (RTKs) for peptide factors, G-protein-coupled serpentine receptors (GPCRs) for neurotransmitters, and calcium influx through voltage-gated calcium channels or N-methyl-D-aspartate (NMDA) receptors for glutamate. Ras activation initiates multiple intracellular signalling cascades, eventually leading to gene transcription. The best-understood effector system downstream of Ras is the MAPK pathway, an evolutionarily conserved signalling cascade. The gene products of ERK1 and ERK2, the two best-characterised MAPKs, are serine/threonine kinases that act as critical transducers of growth factor signalling to the nucleus in mammalian cells. Activation of Ras by extracellular signals leads to sequential activation of Raf (MAPK kinase kinase), MEK (MAPK kinase) and ERKs/MAPKs. Activated MAPKs in turn phosphorylate a large number of substrates, both in the cytosol and in the nucleus. Amongst the major substrates of MAPKs are the RSKs. Protein kinases of this class directly phosphorylate the cAMP response element (CRE)-binding factor CREB, which plays an essential role in inducing expression of many immediate-early genes (IEGs) such as Fos. This fact is particularly relevant, since many forms of neuronal plasticity and learning require functional CREB (Silva et al., 1998). In addition, MAPKs can directly phosphorylate and activate serum response element (SRE)-binding proteins, such as Elk1, thus contributing to the control of gene transcription (Wasylyk et al., 1998).

#### **1.3.4 Learning and memory signaling cascade in *Drosophila***

The relevant findings in *Drosophila* neurogenetics on the role of the cyclic adenosine monophosphate (cAMP) signaling cascade and ERK/MAPK kinase cascade in learning and memory are commonly acknowledged. *Drosophila* represents an important tool to dissect



phases of acquisition and consolidation of memory (reviewed in Heisenberg, 2003; Margulies et al., 2005). *Rut<sup>2080</sup>* and *dnc<sup>1</sup>* are two mutants presenting genetic alterations that affect the cAMP second messenger pathway (Dudai et al., 1976; Livingstone et al., 1984). *Rut<sup>2080</sup>* is a mutant lacking adenylyl cyclase, an enzyme synthesizing cAMP (Levin et al., 1992). *Dnc<sup>1</sup>* is deficient in a cAMP phosphodiesterase usually degrading cAMP (Byers et al., 1981), which was found to be abundantly expressed in the mushroom bodies of the fly (Nighorn et al., 1991). Moreover, disrupting normal cAMP signalling in the MBs by expressing a constitutively active G $\alpha$ s subunit abolishes olfactory learning (Connolly et al., 1996). A third component of the cAMP signaling pathway has also been implicated in *Drosophila* olfactory learning and memory. The cAMP-dependent protein kinase (PKA) is a major mediator of cAMP signaling and it has been observed that one of its main phosphorylation targets is the transcription factor CREB (Taylor et al., 1990) which is crucial in neurons for the formation of long term memory and a substrate of the p90 ribosomal S6 kinase (Johannessen et al., 2004). It has been discovered that mutations in the catalytic domain of PKA showed an impairment in memory performance (Skoulakis et al., 1993). This finding is of special interest as it was also shown that ribosomal S6 kinase (RSK1) can interact with PKA and modify its own functioning and it identifies a previously unknown point of cross-talk between the cAMP and ERK signaling pathways (Chaturvedi et al., 2006). It is now apparent that key regulatory proteins that are sequestered to PKA signaling complexes, namely PDE4 cAMP phosphodiesterases and RSK1, control the functioning of modules (AKAPosomes) formed from AKAP-tethered PKA (Houslay, 2006).

While the previously cited CREB protein has many functions in many different organs, most of them have been related to the brain. CREB proteins in neurons are thought to be involved in the formation of long-term memories; this has been shown in the marine snail *Aplysia* (Mohamed et al., 2005) and in rats (Balschun et al., 2003). In *Drosophila* the evidences is in part contradictory since initial genetic studies of memory formation in *Drosophila* have revealed that the formation of a protein synthesis-dependent long-term memory (LTM) requires multiple training sessions and that LTM is specifically blocked by induced expression of a repressor isoform of CREB (Yin et al., 1994). The same group reports an enhancement of LTM formation after induced expression of an activator isoform of dCREB2 (Yin et al., 1995). More recently these results have been questioned since the original dCREB2-a transgene carries a mutation that produces a translational reading-frame shift with the consequent formation of a stop codon at predicted amino acid position 79. Overexpression of this mutant dCREB2-a transgene or a corrected dCREB2-a transgene

failed to show any enhancement of LTM. Overexpression of the dCREB2-b repressor transgene, in contrast, produced the anticipated block in LTM formation (Perazzona et al., 2004).

*Amnesiac* is another mutant which displays a defective short term memory. Analysis of the locus demonstrated that it encodes three putative neuropeptides, one of which has homology to the pituitary adenylyl cyclase activating peptide (PACAP; Feany and Quinn, 1995). This suggested a potential mechanistic link between *amn* and *dnc* via modulation of cAMP levels by neuropeptide signaling through a G protein-coupled receptor that signals through the *rut* adenylyl cyclase (Kandel and Abel, 1995). It has also been demonstrated that cell adhesion molecules and membrane receptors contribute to learning and memory. Two proteins located on the cell surface, the  $\alpha$ -integrin subunit deleted in the *Volado* mutant (Grotewiel et al., 1998) and a second cell adhesion molecule, encoded by the *fasciclin II* gene support short term memory (Cheng et al., 2001), while a mutant for the receptor mutant *notch* is impaired in long term memory (Presente et al., 2004).

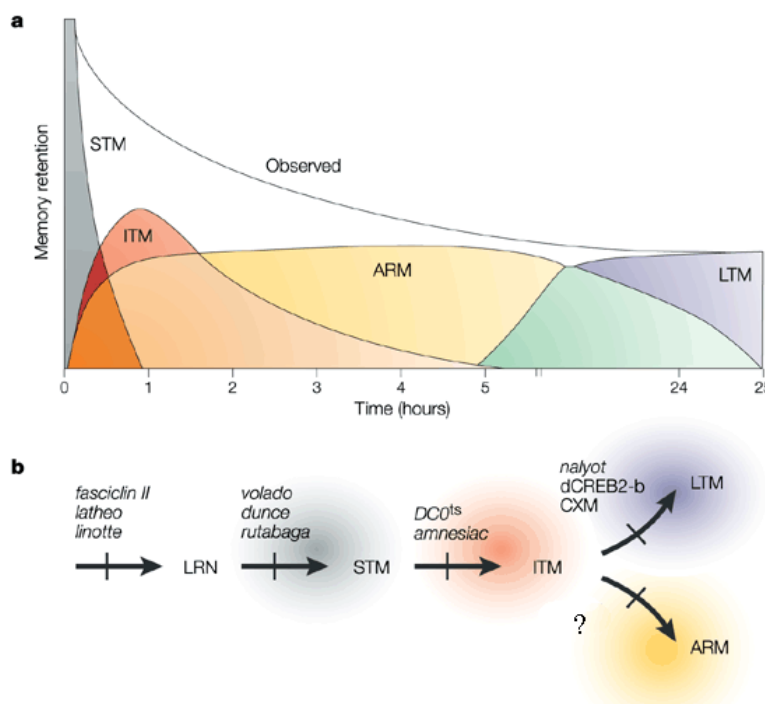
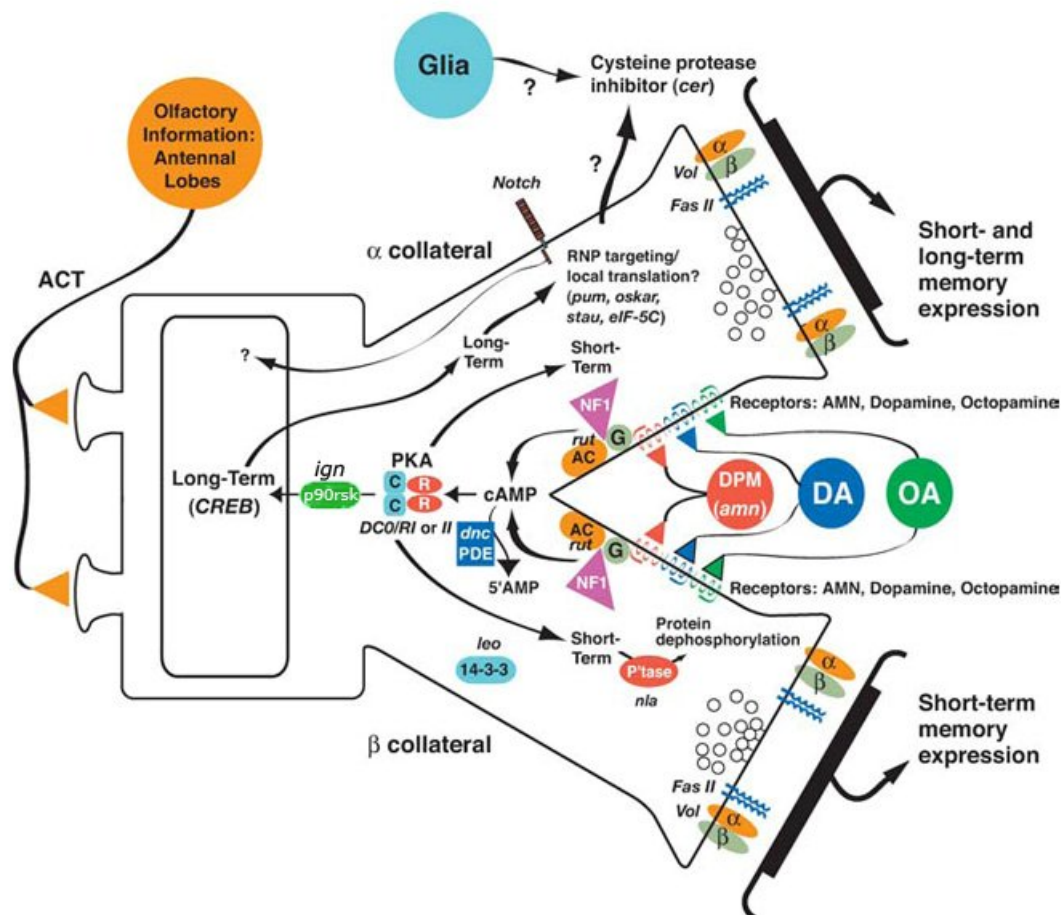

**Figure 1-5: Memory phases**

(a) Distinct memory phases: short-term (STM), intermediate-term (ITM), anesthesia resistant (ARM), and long-term (LTM) memory. (b) Genetic dissection of memory phases in *Drosophila*: in this graph the genetic components described in the main text are displayed on a “genetic” pathway reconstructed by analyzing the disrupted memory phases of the respective mutants (figure modified from Tully et al., 2003)

There are several other mutants which have been lately discovered and need further analysis to improve the understanding of the biochemical network underlying learning and memory in *Drosophila* (see Figure 1-6), these are: *cramer* (*cre*), a cysteine protease inhibitor (Comas et al., 2004), genes coding for ribonucleoprotein particles *staufen* (*stau*), *pumilio* (*pum*), *oskar* (*osk*) and eIF-5C (reviewed in Dubnau et al., 2003; Dubnau et al., 2003), *latteo*

(*lat*) (Boynton and Tully, 1992), *nebula* (*nla*) an inhibitor of calcineurin (Chang et al., 2003) and *leonardo* which codes for a 14-3-3 family protein that is highly expressed in mushroom body neurons and directly binds to Raf (Skoulakis and Davis, 1996). In another case *radish*, identified as a phospholipase-A2 (Folkers et al., 1993), was thought necessary for anesthesia resistant memory formation (Chiang et al., 2004; Folkers et al., 2006), but recently it was realized that this claim was incorrect. The results were not reproducible and *radish* encoded a different gene (Chiang et al., 2007).



**Figure 1-6: Current model of molecular pathways involved in memory formation.**

Olfactory information is conveyed by the antennal cerebral tract (ACT) to the MB neurons, with unconditioned stimulus (US) information potentially being conveyed, in part, by dopaminergic (DA) and/or octopaminergic (OA) modulatory neurons. The dorsal paired medial (DPM) neurons that express the *amn*-encoded neuropeptides may provide input to the MB neurons for olfactory memory persistence or consolidation. In the model depicted, the DA, OA, and DPM inputs activate the adenylyl cyclase (AC) product of the *rutabaga* (*rut*) gene through G protein (G)-coupled receptors. The product of the *NF1* gene, neurofibromin, is thought to be involved in the activation/maintenance of AC activity. The activation of AC produces elevations in the concentration of intracellular cAMP. The *dunce* (*dnc*)-encoded phosphodiesterase degrades cAMP. In the absence of this enzyme, cAMP is elevated to intolerable levels, which compromises olfactory learning. Cyclic AMP activates the protein kinase A (PKA) tetramer by causing the release of the inhibitory PKA-regulatory (RI or RII) subunits from the catalytic (C) subunits. The *DC0* gene encodes the catalytic subunit of PKA. The activation of PKA leads to either the phosphorylation of a variety of substrates for the establishment of short-term memory or the phosphorylation of CREB for the establishment of long-term memory. The *nebula* (*nla*) gene may be required for normal learning through its control of protein phosphatase activity. The *Volado* (*Vol*)-encoded integrin and

*fasII* are cell-adhesion receptors that may mediate signaling or physical alterations of the MB synapses that are important for memory formation. Other genes reported to be involved in olfactory learning potentially by mediating alterations in MB neuron physiology include *leonardo* (*leo*), encoding a 14-3-3 protein, and *Notch*, a cell-adhesion receptor reported to be specifically involved in long-term memory. Recent data have interpreted that long-term memories may form only in the  $\alpha/\alpha^1$  collaterals of MB neurons, perhaps in part through the translocation of mRNA in ribonucleoprotein particles (RNP) and the activation of local protein synthesis. The *crammer* gene (*cer*) encodes an inhibitor of cysteine proteases that is required for long-term memory and may be expressed in the MB neurons, in the nearby glia, or in both of these cell types (figure modified from Davis, 2005). The role of p90rsk and the effect of the disruption of its gene (*ignorant*, *ign*) on learning and memory has been addressed in previous studies (Bertolucci, 2002; Putz, 2002) and will be further discussed in this work.

## **1.4 Morphological approach to learning and memory analysis**

### **1.4.1 The mushroom bodies**

The mushroom bodies (MBs) of *Drosophila* are bilaterally symmetric structures formed by approximately 2500 intrinsic neurons per brain hemisphere, also known as Kenyon cells (KCs). The dorsal posterior part of the brain is the place where the cell bodies of these neurons are situated. Their dendrites spread anterior and ventral in respect to the cell bodies, forming a bulbous ramification which is called calyx and is the input location for the signals coming from the projection neurons (PN), while the input pathways of other sensory stimuli have not been identified yet. The axons of the Kenyon cells project to the anterior portion of the brain forming a structure known as peduncle (Technau and Heisenberg, 1982; Strausfeld et al., 2003).

All of the KCs derive from four neuroblasts originating during larval and pupal development (Ito et al., 1998). Each of them produces consecutively three types of neurons: the one developing first project to the  $\gamma$  lobe, then the cells originating after the mid-third instar larval stage project into the  $\alpha'/\beta'$  lobes, to end with the neurons generated after the puparium formation which project into the  $\alpha/\beta$  lobes (Lee et al., 1999). MBs are longitudinally subdivided into parallel partitions. Early anatomical studies of the brain of the cockroach *P. americana* by Bretschneider (1914) demonstrate longitudinal subdivisions in the pedunculus and lobes (also described in Mizunami et al., 1998). Each subdivision presents coupled laminae, one of which stains light and the other dark following the Bodian method (Strausfeld and Li, 1999; Strausfeld and Li, 1999). Light laminae have affinities to taurine, NOS, and several modulatory peptides. Each lamina is made-up of several smaller subunits (called leaves), each composed of a set of axons from one morphological type of Kenyon cells, as defined by its dendritic morphology in the calyx. GAL4 enhancer trap lines of

*Drosophila* demonstrate longitudinal subdivisions within the pedunculus, and lobes (Yang et al., 1995).

The best studied function of the MBs is olfactory learning and memory (reviewed in Gerber et al., 2004).

Different techniques were developed for studying MB function by blocking Kenyon cells, by ablation or using developmental defects of mutants. Two distinct morphological mutants with deranged or miniaturized MBs were impaired in olfactory learning and memory (Heisenberg et al., 1985). Applying hydroxyurea (HU), a cytostatic drug, during the first larval instar caused a complete or partial lack of the MBs. Also in this case, flies failed to perform normally in an olfactory conditioning test (de Belle and Heisenberg, 1994). Genetically blocking the neuronal output of the MBs revealed that Kenyon cells are required during retrieval and not during the acquisition phase (Dubnau et al., 2001; McGuire et al., 2001; Schwaerzel et al., 2002). Requirement of the MBs was demonstrated by MB-targeted expression of a mutated constitutively active *G $\alpha$ s* protein, which disrupted learning without impairing the basic sensory and motor functions required for this behavior (Connolly et al., 1996). In order to obtain genetic evidence for sufficiency of a molecular pathway in a specific structure, the behavioral defects of a mutant can be rescued with spatially or temporally restricted expression of the wild-type gene through the GAL4-UAS system. This technique was used to identify the ventral ganglion, the antennal lobes, and the median bundle as sufficient structures of the central nervous system which rescue the spatial learning defect of *rut* mutants in the heat-box (Zars et al., 2000).

In the heat-box MB less flies (after hydroxyurea feeding) still showed considerable spatial preferences indicating that place conditioning is MB independent (Wolf et al., 1998; Putz and Heisenberg, 2002). In addition using a flight simulator (Wolf and Heisenberg, 1990), it was shown that the MBs are not necessary for visual associative learning (Wolf et al., 1998) while they support context generalization (Liu et al., 1999).

#### 1.4.2 The GAL4-UAS system

GAL4 encodes a protein of 881 amino acids, identified in the yeast *Saccharomyces cerevisiae* as a regulator of genes induced by galactose (Laughon et al., 1984). It regulates the transcription of two genes (*GAL10* and *GAL1*) by binding to four related 17bp sites located between these loci (Giniger et al., 1985). This DNA sequence called Upstream Activating Sequence (UAS), analogous to an enhancer element of multicellular eukaryotes, is essential for the transcriptional activation of GAL4-regulated genes (Duffy, 2002). In *Drosophila* this

UAS element enhances the expression of any downstream adjacent gene if GAL4 is expressed and binds to the UAS. This is called the GAL4-UAS system: An enhancer that determines the cell specific expression of GAL4 is combined with the UAS coupled transgene (effector gene) of one's choice. It now drives the transcription of the effector gene with the same cell-specific pattern (Figure 1-7).

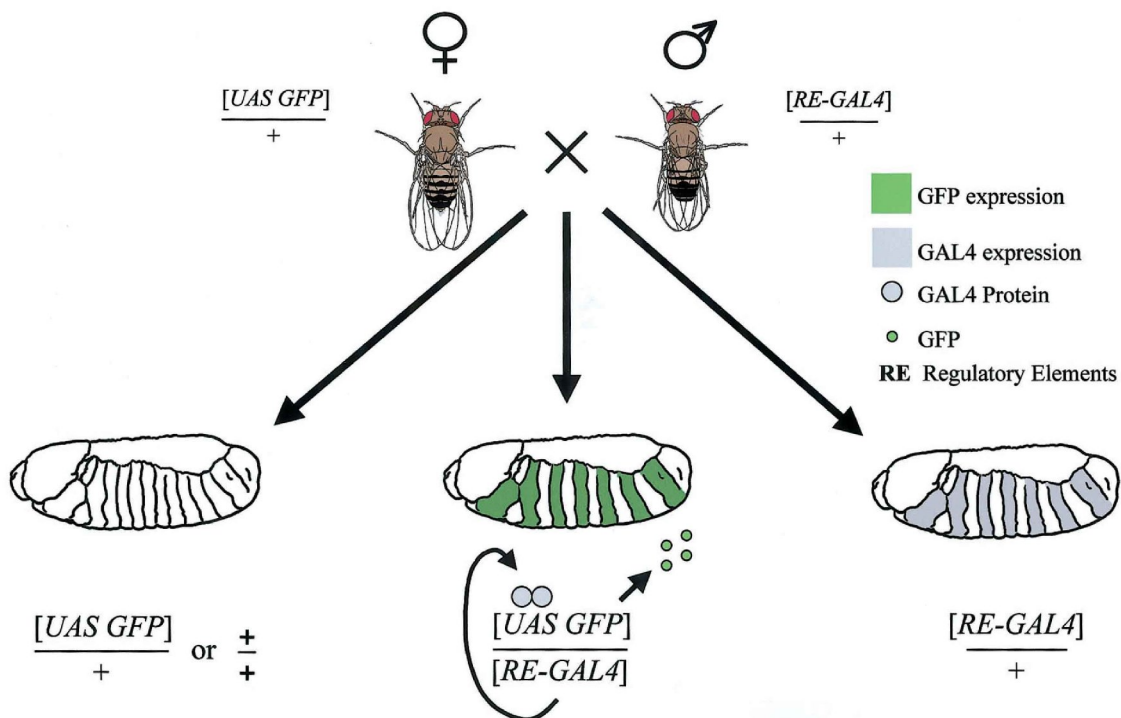

**Figure 1-7: The UAS/GAL4 system in *Drosophila*.**

When females carrying a UAS effector gene (*UAS-GFP*) are mated to males carrying a GAL4 driver, progeny containing both elements of the system are produced. The presence of GAL4 in an alternating segmental pattern in the depicted embryos then drives expression of the UAS effector gene in a corresponding pattern (figure from Duffy, 2002).

This bipartite approach using two separate parental lines, the effector line and the driver line, has two major advantages. First, the transcriptional inactivity of the parental effector line means that transgenic effector lines can be generated for gene products that are toxic. Second, one can target the expression of any effector gene in a variety of spatial and temporal patterns by mating it with respective GAL4 drivers (Brand and Perrimon, 1993).

The GAL4-UAS system provides also free temporal control if GAL4 is combined with the heat-shock promoter (*hsp-70*). By raising the temperature from the restrictive level to the permissive one the UAS coupled effector gene can be expressed (Slater and Craig, 1987).

For functional analysis, a large number of UAS-effectors and GAL4 drivers are available.

## **1.5 Learned helplessness**

Not only genetic or chemical intervention can produce learning and memory deficits, also individual experiences can lead to a learning impairment (Seligman and Maier, 1967). For example exposure to inescapable shock can lead to a profound disruption of learning ability. This phenomenon, known as Learned Helplessness (LH), has been proposed as an animal model of depression since some of the behavioral changes observed in animals exposed to inescapable shock share similarities with clinical depression in humans (reviewed in Shors, 2004). Seligman discovered LH by accident whilst studying the effects of inescapable shock on active avoidance learning in dogs (Seligman and Maier, 1967). The LH theory had a major influence on psychological research in the 1970s.

In one of the studies, Seligman and Maier divided dogs into three groups. The first two groups consisted of "yoked pairs." That is, one dog of each pair received an electric shock that it could terminate, and the other dog in each pair simultaneously received the same amount of shock. To this second dog, the shock seemed to stop at random, because it was the first dog that was ending the shock. The dogs with no control over the shocks were said to receive "inescapable shock." The third group of dogs was composed by control subjects who received no shock in this phase of the experiment. Next, all three groups were tested in a shuttle-box apparatus, in which the dogs could escape electric shock by jumping over a partition. The dogs that performed poorly in the shuttle-box were those that had received inescapable shock in the pre-treatment phase of the experiment. They did not try to escape, but rather passively accepted the painful shocks. Dogs in the control group, as well as dogs that had been pre-treated with controllable shock, tended to jump over the partition and to escape the shocks. Since the dogs which had experienced escapable shock behaved in the same manner as the control dogs, Seligman and Maier claimed to have demonstrated that it was the perceived inescapability of the shocks, and not the shocks alone, which explained the passive behavior (Seligman and Maier, 1967). These experiments provided evidence that a psychological variable such as uncontrollability could subsequently in a different task influence an animal's ability to respond when control was possible. Performance was most often assessed during operant conditioning (Overmier and Seligman, 1967). LH was not the only symptom arising after the uncontrollable shock treatment; other disturbances like sleep and eating disorder, ulcers and decreases in immune status were also commonly registered. It appeared that the animals had "given up", therefore the phenomenon was a reliable animal model for depression in humans (Miller et al., 1975), the rationale being that exposure to uncontrollable

and stressful stimuli leads to a feeling of loss of control, which eventually leads to depression-like behavior (reviewed in Shors, 2004).

Although generally accepted in modern times, the LH phenomenon (or at least its interpretation) was historically a controversial issue. For a long time two main theories confronted each other, one cognitive in nature, the other performance-based. The cognitive version assumed that during exposure to the inescapable shocks, the animal learns that the shock and its response are not contingent and therefore is later impaired in building significant contingencies (Willner, 1984). The other prevailing theory was that the performance decrement reflects a decrease in activity, which results either from associating the shock with a general inactive response, or is basically a consequence of a failure in the neurotransmitter network (Sherman and Petty, 1980). Later, results suggested that the deficit in the learning performance could be a consequence of deficits in selective attention rather than learning per se (reviewed in Willner, 1984).

More recently, several studies led to conflicting conclusions, revealing that a rationalization to the LH phenomenon is still far from being fully accomplished (Jackson et al., 1979; Wasserman and Miller, 1997; Miller and Matzel, 2000; Cahill et al., 2001). Learned helplessness has been observed in humans (reviewed in Kim and Diamond, 2002), dogs (Seligman and Maier, 1967), cats (Seward and Humphrey, 1967), rats (Trevor R. Norman, 2000) and goldfish (Nash et al., 1983) and among the invertebrates it has been studied in cockroaches (Brown and Stroup, 1988), slugs (Brown et al., 1994) and *Drosophila* (Brown et al., 1996).

### **1.5.1 Sex differences in learned helplessness**

In humans women are more susceptible than men to stress-related psychiatric disorders, i.e. major depression, anxiety syndromes, acute and post-trauma stress disorders (Kessler, 2003; Holden, 2005). In addition to increased incidence, their depressive episodes can last longer, are more severe and often recur (Nolen-Hoeksema, 1987). This difference is poorly understood. While some environmental and sociocultural factors may contribute to it (Egeland and Hostetter, 1983; Nolen-Hoeksema, 1991), the factor considered most relevant is the influence of sexual hormones (Matheson and Anisman, 2003). In female rats the response to stress is typically characterized by a greater release of both adrenal corticotropic hormone (ACTH) and corticosterone compared to males (Rivier, 1999). Another cue is that female rats in the diestrus II phase had significantly higher escape latencies and exhibited a more helpless behavior than female rats in the estrus phase. Male rat escape



latencies were intermediate between the two female phases (Jenkins et al., 2001). There are also studies which reveal anatomical differences and diverse patterns of brain activity in males and females. These evidences led to the suggestion that it should become standard performing pharmacological and stress studies not only in males but also in females (Renard et al., 2005). Generally the main cause of the gender differences in the pathophysiology of depression remain poorly understood. At present there are no reported studies about a sexual dimorphism of learned helplessness in arthropods

### **1.5.2 Learned helplessness and serotonin**

Serotonin (5-hydroxytryptamine, 5-HT) plays an important role in a variety of complex traits such as appetite, body temperature, sleep, aggression, sexuality and mood (Heninger, 1997). Moreover, in a number of these traits its effect is sex specific. For example, serotonin dysfunction has been identified in women with premenstrual dysphoric disorder (Steiner et al., 1999), a condition which is positively correlated with mood disorders (among them depression) (Steiner et al., 1999) and it is likely that serotonin contributes to aggression in males by interacting with testosterone (Clark and Henderson, 2003). The genetic basis underlying serotonin effects is still poorly understood although there are clear hints of genetically caused dysfunction (Abney et al., 2001).

Serotonin is the target of a class of antidepressants, the selective serotonin reuptake inhibitors (SSRIs), which are used to cure depression and anxiety disorders and are the most widely prescribed antidepressants in many countries. They inhibit the reuptake of 5-HT from the synaptic cleft into the presynaptic cell. This increases the amount of serotonin that can bind to the postsynaptic receptor. This class includes drugs such as citalopram (brand name: Celexa) and fluoxetine (brand name: Prozac). A different category of antidepressants is based on 5-Hydroxytryptophan (5-HTP), an amino acid and a precursor to serotonin (reviewed in Turner et al., 2006).

### **1.6 Aim of this study**

Modulating a motor pattern in response to its effects is substantially different from associating two sensory stimuli. Therefore, it is to be expected that the molecular and cellular mechanisms for operant and classical learning differ. In one study in *Drosophila*, it had been shown that in classical olfactory discrimination learning and operant place learning in the heat-box different circuits are involved and that memory traces are found at different locations

(Zars et al., 2000; Zars et al., 2000a). With one of these paradigms, place learning in the heat-box, a large mutant screen had been conducted and had resulted in the isolation of the gene *ignorant (ign)* (Putz et al., 2004) encoding p90 ribosomal S6 kinase II (S6KII), a member of the serine-threonine kinases family. The closest mammalian homologue, *rsk2* belongs to the MAPK signalling cascade and is involved (among other functions) in synaptic plasticity and learning. It was shown that *ign* serves different functions in operant and classical conditioning. While in null mutants only Pavlovian learning is affected, a P-element insertion mutant reducing the amount of S6KII only affects operant learning. Mutants lacking part of the N-terminal kinase domain perform poorly in both learning tasks (Bertolucci, 2002; Putz, 2002). The aim of this thesis was to gain deeper insights into the involvement of S6KII in the two types of associative learning.

Both olfactory learning and place learning require cAMP signaling but have their cAMP dependent memory traces in different neurons (Zars et al., 2000; Zars et al., 2000a). This prompted the question whether the cAMP cascade and the molecular functions of *ign* co-localize in the same neuronal structures. Possibly, in synaptic plasticity the cAMP and MAPK signaling cascades are linked by the *ign* gene.

What had begun as a side project for trying to show pure operant learning in the heat-box, rapidly developed into a challenging effort to observe **learned helplessness** in *Drosophila*. Results indicated that learning in the heat-box might indeed be a suitable paradigm for observing this phenomenon. Therefore, attempts were made to find out whether flies learning in the heat-box could serve as a screening test for antidepressants.

## 2 Materials and Methods

### 2.1 Flies

#### 2.1.1 Fly care

The animals were raised on corn-meal food at a 14:10 hours light-dark cycle at 25°C and 60% relative humidity (Guo et al., 1996). Experimental flies were fed on fresh food vials for up to 48 hours before being tested. For behavioral experiments, I used 3 to 6 day old males and females in mixed groups, either taken from homozygote lines or from progeny of crosses between homozygote parental lines. All classical conditioning experiments were done at 26°C and 80% relative humidity, under red light (invisible to the flies) during the training phase and in complete darkness during the test, while the operant conditioning assays were performed in darkness at 25°C during the not-punished phase and 37°C during the punished phase.

#### 2.1.2 Genotypes

I used the Canton-S (Würzburg stock collection) as a wild-type control. For *rutabaga* experiments was used the allele *rut<sup>2080</sup>*. Behavioral experiments were done with animals from these homozygous lines. To drive transgenic expression within the Kenyon cells of the mushroom bodies (MBs) I used pan-neuronal *Gal4*-lines like *elav-GAL4* or *nSyb-GAL4* and the mushroom bodies specific *mb247-GAL4*-line (Zars et al., 2000), this line drives expression in nearly all subsystems of the MBs, other more specific *GAL4* enhancer trap lines like *30y* and *c232* or more broadly expressed like *c772* were tested.

#### 2.1.3 Fly strains

Line	Genotype	Reference
Canton-S	wildtype	Putz et al. , 2004
<i>rutabaga</i>	allele <i>rut<sup>2080</sup></i>	Zars et al., 2000b
<i>FM7a</i>	balancer strain, cantonized	Biozentrum, Wü

<i>TM2</i>	balancer strain, cantonized	Biozentrum, Wü
<i>CyO</i>	balancer strain, cantonized	Biozentrum, Wü
<i>8522 = ign<sup>PI</sup></i>	placW insertion	Schäfer U.
<i>hs-GAL4</i>	heat shock GAL4 promotor	Poeck B.
<i>elav-GAL4</i>	GAL4 promotor	Biozentrum, Wü
<i>nSyb-GAL4</i>	GAL4 promotor	Simpson J.
<i>mb247-GAL4</i>	GAL4 promotor	Biozentrum, Wü
<i>c772-GAL4</i>	GAL4 promotor	Biozentrum, Wü
<i>30y-GAL4</i>	GAL4 promotor	Biozentrum, Wü
<i>C232-GAL4</i>	GAL4 promotor	Biozentrum, Wü
<i>UAS-RNAi</i>	S6KII-RNAi under UAS control	Keleman K.
<i>Df(1)ign<sup>A58/1</sup></i>	excision line of 8522 (4762 bp deleted)	Putz et al. , 2004
<i>Df(1)ign<sup>A24/3</sup></i>	excision line of 8522 (1322 bp deleted)	Putz et al. , 2004
<i>T1</i>	Transgenic line, insertion at 2 <sup>nd</sup> chromosome	Putz et al. , 2004
<i>T2</i>	Transgenic line, insertion at 2 <sup>nd</sup> chromosome	Putz et al. , 2004
<i>T3</i>	Transgenic line, insertion at 3 <sup>rd</sup> chromosome	Putz et al. , 2004
<i>T4/1</i>	Transgenic line, insertion at 3 <sup>rd</sup> chromosome	Putz et al. , 2004
<i>T4/2</i>	Transgenic line, insertion at 1 <sup>st</sup> chromosome	Putz et al. , 2004
<i>T5</i>	Transgenic line, insertion at 3 <sup>rd</sup> chromosome	Putz et al. , 2004
<i>T6</i>	Transgenic line, insertion at 1 <sup>st</sup> chromosome	Putz et al. , 2004
<i>UAS2</i>	Transgenic S6KII under UAS control, 2 <sup>nd</sup> chromosome	Schäfer
<i>UAS3</i>	Transgenic S6KII under UAS control, 3 <sup>rd</sup> chromosome	Schäfer
<i>58/1;UAS2</i>	Transgenic UAS-S6KII 2 <sup>nd</sup> chr., in null background	Putz et al. , 2004
<i>58/1;UAS3</i>	Transgenic UAS-S6KII 3 <sup>rd</sup> chr., in null background	Putz et al. , 2004
<i>58/1; rut</i>	Double mutant: <i>Df(1)ign<sup>A58/1</sup></i> recombined with <i>rut<sup>2080</sup></i>	Biozentrum, Wü

The original P-element insertion on the first exon of the S6KII gene comes from a collection of X-chromosomal insertion lines of the P[lacW] element provided by Dr. Ulrich Schäfer (Max-Planck Institute for Biophysical Chemistry, Göttingen, Germany). Precise and imprecise excision lines of P-element line *ign<sup>PI</sup>* were generated by remobilization of the P(lacW) with introduction of a stable transposase source (Robertson et al., 1988). Strains were periodically crossed to wild-type Canton S (WT-CS) for several generations and made homozygous (Putz et al., 2004). The 6.5 kb genomic fragment used for rescue experiments

was cloned into a pW8 transformation vector (Klemenz et al., 1987). Transgenic lines were generated by injecting Qiagen-purified plasmid DNA into *w1118* embryos. Six independent transgenic lines were established and cantonized for generations (Putz et al., 2004).

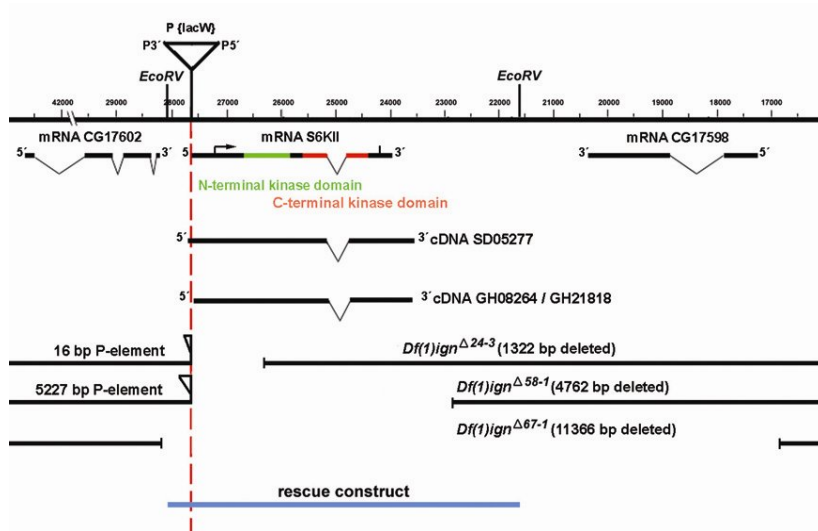

**Figure 2-1: Molecular map of the S6KII gene (partitions, 0.5 kb)**

The following are shown: EcoRV restriction sites; insertion site of P(lacW) of the *ign<sup>P1</sup>* mutant; the exon/intron structure of S6KII and predicted neighboring genes; structure of sequenced cDNAs (SD0522, GH21818, and GH08264); extension of deletions, the rescue construct cloned in the transgenic lines (T1-T6) and the regions amplified by RT-PCR.

Abbreviations: N-K = N-terminal kinase domain, C-K = C-terminal kinase domain (modified figure from Putz et al., 2004).

### 2.1.4 *Drosophila* crosses

To generate a line which included both the S6KII null mutation (line 58/1) and the P-element insertion of the *rut<sup>2080</sup>* allele, a series of crosses was completed as explained in the scheme below.

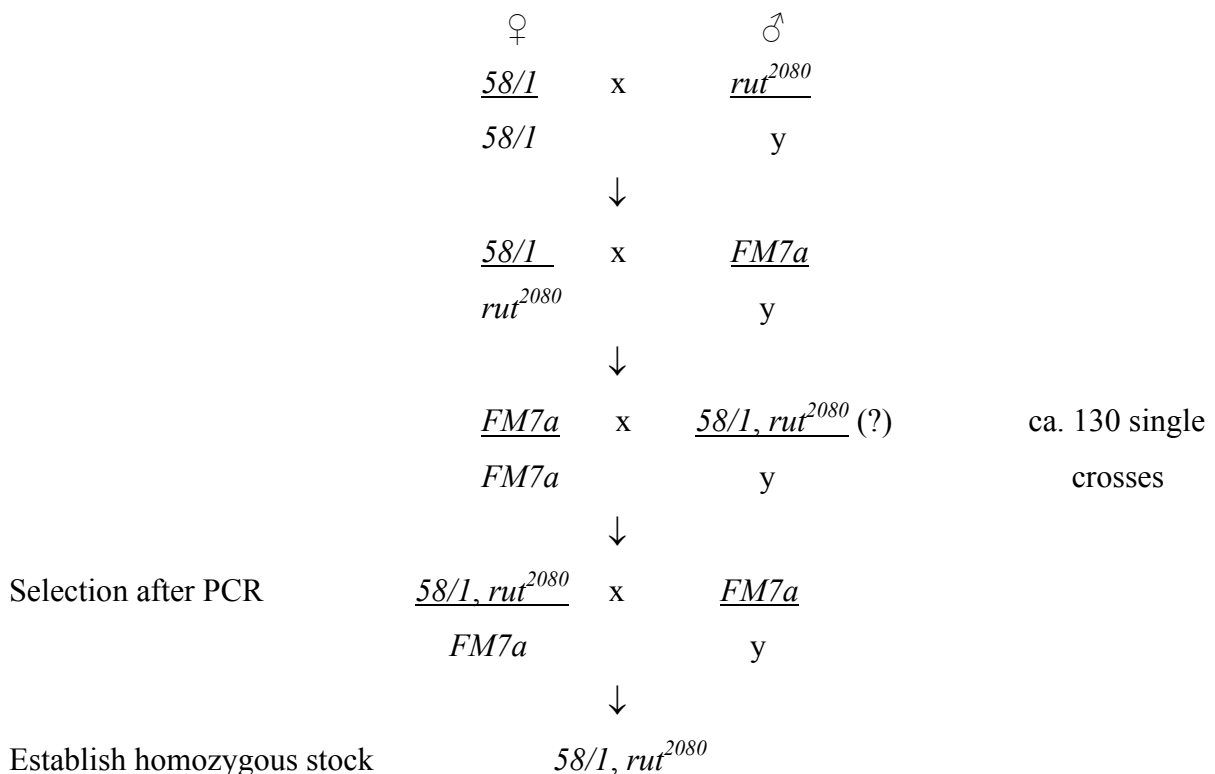

To generate a line which included both the S6KII null mutation and the cDNA of the S6KII gene under UAS control (UAS2), a series of crosses was completed like in the next scheme.

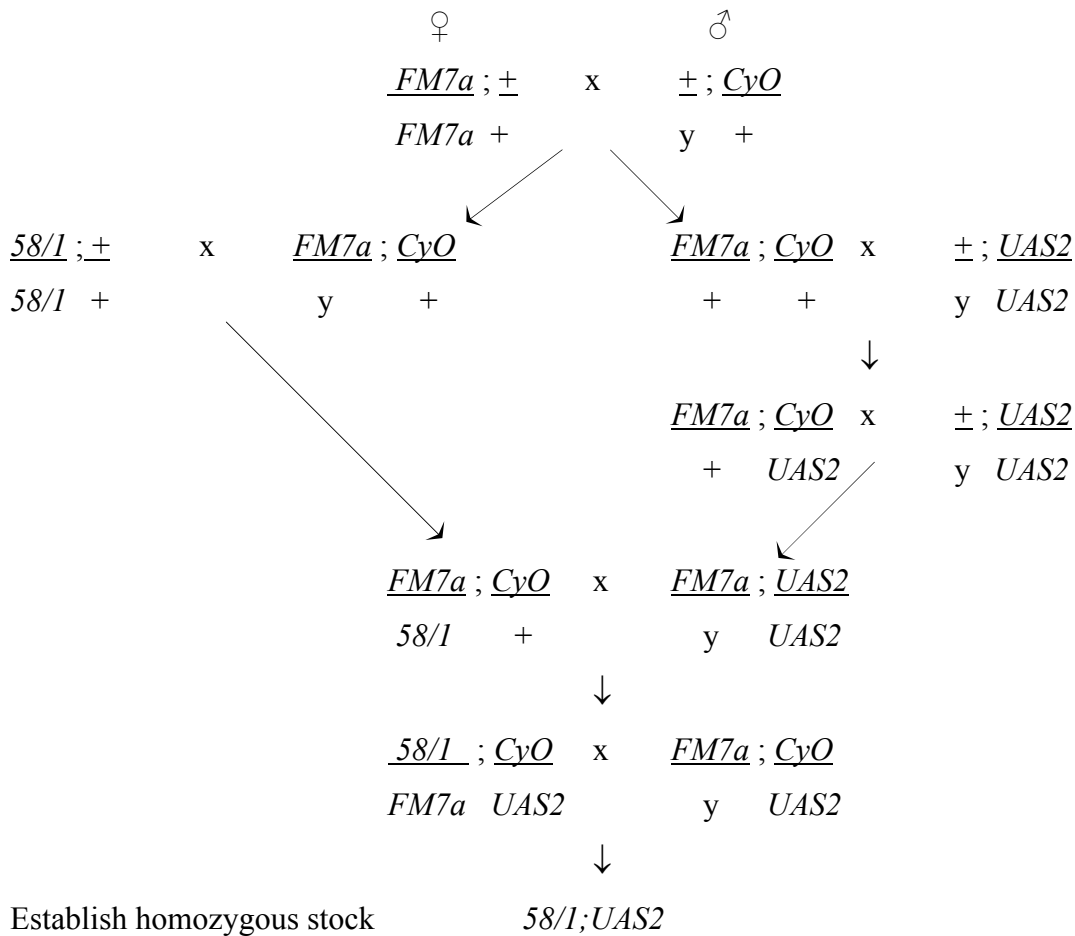

In order to map the insertion of the transgenic lines used for protein overexpression analysis and for genomic rescue experiments, a series of crosses was completed like explained in the scheme below. CyO and TM2 on  $w^{1118}$  were the balancers used in this procedure.

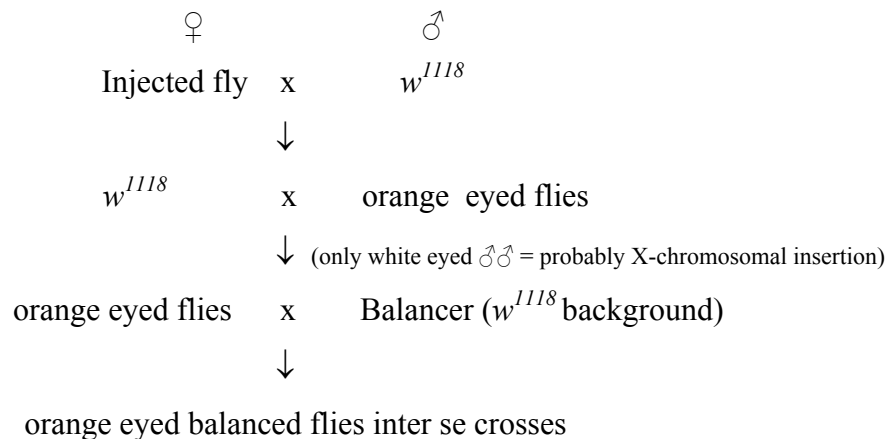

offspring numerical analysis of white and orange eyed balanced flies.

no white eyed CyO = 2<sup>nd</sup> chromosomal insertion; no white eyed TM2 = 3<sup>rd</sup> chr. insertion.

## **2.2 Behavioral paradigms**

In this section are described the different apparatus and techniques utilized during the classical and the operant conditioning experiments.

### **2.2.1 The olfactory revolver device**

For the conditioning of flies a modification, arranged by M. Schwärzel, of the conditioning apparatus created by Dudai et al. (Dudai et al., 1976) was used and improved by Tully et al. (Tully and Quinn, 1985) so that four experiments could be performed simultaneously. This apparatus, called the “Revolver”, consists of four training tubes with 95% of their inner surface electrifiable, eight test tubes, a sliding internal disc with four compartments to transfer flies after training and four two-armed choice points for testing relative odor avoidance responses.

The training tube consists of a polystyrene test tube with an electrifiable coiled copper wire attached to the inner side, a circular nylon grid on the distal end of the tube prevented flies from escaping while allowing the odorized air stream to enter. 0,5mm holes were drilled through the epoxy backing between the copper lanes of a circular grid to allow air to enter the training tube. Each arm (collection tube) of the choice point used for the test trial consisted of a polystyrene test tube with a net grid at the bottom to allow air to enter the collection tubes and to exit at the center choice point. Each odor cup was housed in a plastic cylinder with a cup on the top presenting 7 holes (0,2mm). The odorants were contained in about 10mm deep cups; these “odor cups” were inserted on the upper side of a Plexiglas base cube, which supported the odor cup, anchored the cover cylinder and enabled the flow of the odorized air into the collection tube.

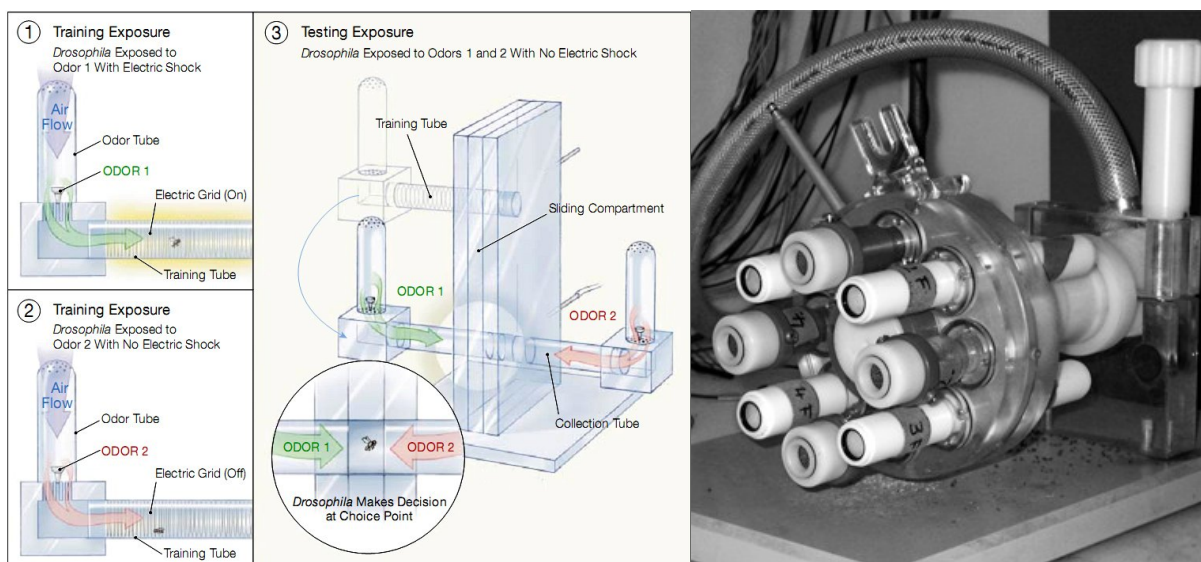

**Figure 2-2: T-maze olfactory learning device**

The principle of the paradigm is based on the T-maze device of Tully & Quinn (1985). At the beginning of an experiment, about 50-100 flies are put into a training tube and from there gently tapped into the elevator chamber. During the test, the movable compartment is pushed down and the chamber is aligned with the two tubes at the choice point. From there, flies can enter one of the two collection tubes. With no stimuli presented, flies distribute equally between the tubes. The apparatus consists of two horizontal (test) tubes, opened to the space of the chamber in the movable compartment. At the top of the machine is a training tube lined with copper wire connected to an electric shock generator. To all of those tubes, a holder with teflon odor cup can be attached. Air is continuously pumped from the machine at a constant flow rate of 750 ml/min. To test a naive response towards an odor, shock tube is used only to collect flies before they are tapped to the chamber and slid to the choice point. No electric shock is given. For learning experiments, flies are given a series of electric shocks while in the shock tube (modified figure from Friedrich, 2000). On the right is displayed the modified T-maze consisting of four independent T-mazes placed on a rotating disc (Schwaerzel et al., 2002), so that it allows to train and test four independent groups of flies simultaneously.

Before an experiment, the odor cups were filled with pure solution of either 3-octanol (OCT) or benzaldehyde (BEN). 900µl of 3-octanol were added in four 16,0mm cups and 100µl of benzaldehyde in another four 5,0mm cups. Under conditions of constant air speed, odor concentrations were adjusted by varying the diameters of the odor cups until naive flies distributed randomly when given a choice between 3-octanol and benzaldehyde. The odors were sucked out by a vacuum pump, which produced a pulse-free stream of air (750ml/min). The air exhaust was piped out of the room. The conditioning apparatus was placed in an isolated chamber where temperature and humidity could be controlled during the experiments. A 1,25s, 130V square-wave impulse was provided by a manually controlled stimulator. After each day of experiments the cups and the cylinders were washed with diluted Triton X100 (Carl Roth Ltd.) and placed into a chamber overnight at 40°C to remove odorant traces.

### 2.2.1.1 Electric shock sensitivity test

The test was performed in a T-maze assay (Tully and Quinn, 1985) within the described apparatus. About 100 flies were placed into the machine and given one minute to



choose between an electric shocked tube and a non-shocked tube. For each experiment after 120sec the number of flies choosing the shocked tube ( $N_{\text{shock}}$ ) or the non shocked tube ( $N_{\text{non shock}}$ ) was counted and a Performance Index as  $PI = [(N_{\text{shock}} - N_{\text{non shock}}) / (N_{\text{shock}} + N_{\text{non shock}})] * 100$  was calculated.

### **2.2.1.2 Odorant acuity test**

The test was performed in a T-maze assay (Tully and Quinn, 1985) within the described apparatus. About 100 flies were placed into the machine and given one minute to choose between two tubes, one connected with an odorant source device filled with the specific odor to test and the other connected with an empty odorant source device. For each experiment after 120sec the number of flies choosing the shocked tube ( $N_{\text{shock}}$ ) or the non shocked tube ( $N_{\text{non shock}}$ ) was counted and a Performance Index as  $PI = [(N_{\text{shock}} - N_{\text{non shock}}) / (N_{\text{shock}} + N_{\text{non shock}})] * 100$  was calculated.

### **2.2.1.3 Classical conditioning experiment**

Before each experiment every training tube was gently cleaned with a piece of paper rolled on a brush and tested for electric conductance. The chamber was heated to 25°C and humidity was raised to about 70% – 80%. Every 2 weeks the training tubes were polished with a turning lathe and cleaned with a brush. The 8 test tubes (4 for each side) were connected to the conditioning apparatus; the lever for the turning of the internal disc was put on the very left position to permit airflow through the training tubes. At the start of a training cycle 100 to 150 naïve flies were aspirated in the four training tubes, which were the connected one by one to the apparatus. Subsequently each training tube was connected to the wires providing the electric pulse. A single test shock was given to check for short circuits. The pump and the timer were activated simultaneously, white light was turned off and red light was turned on to avoid the influence of visual stimuli.

During the first 90 seconds of the rest interval no odor was presented. After this 90s the odor cylinders, two with OCT and two with BEN, (Conditioning Stimulus +) were connected to the training tubes and paired with twelve electric shock pulses (Unconditioned Stimulus), one every 5s. After 60s the stimulator was switched off and the odor cylinders and the wires were removed so that for 45s only clean air could flow into the tubes. In the subsequent 60s the flies were exposed to the alternative odor (Conditioning Stimulus -), to flies which were punished during 3-octanol presentation benzaldehyde was given and to flies

which were punished during benzaldehyde presentation 3-octanol was given without punishment. After the CS- presentation the odors were removed and flies had again a rest period of 45s to complete a single training trial. During training, flies were not shaken or jarred; minimizing disturbances to flies appeared to be necessary to obtain maximal learning scores. The lever was then turned to the very right position to connect the collecting chambers of the internal disc to the proximal exit of the training tubes, flies were then gently tapped in the center compartments and trapped by turning the lever in the middle position, so that the center compartments were not communicating with any exit. The training tubes were removed and the odor cylinders were connected to the test tubes, with 3-octanol on the front side and benzaldehyde on the rear side of the apparatus. This operation took approximately 100s and as the odors were placed correctly, red light was turned off and the rest of the experiment was performed in total darkness. The lever was turned to the very left position so that the center compartments could slide smoothly into register with the choice point. Flies had 120s to disperse from the center compartment into the collection tubes. After this period the lever was turned rapidly to the central position, trapping flies in the collection tube they had chosen. Finally, flies in each collection tube were anaesthetized with CO<sub>2</sub> and counted. Usually, 4 to 8 flies remained in the center compartments; these were discarded.

To avoid the influence of naive odor preferences, the PI was calculated by taking the mean between two simultaneous reciprocal experiments, in one experiment one odor (OCT or BEN) was the CS+ and in the other experiment the same odor was the CS-. This method eliminates any small bias that the flies may show to one odor versus another and the only way to obtain a learning index greater than zero is if the flies learn to avoid the shock-paired odor (Tully and Quinn, 1985).

For concentration learning, instead of two odorants, two different dilutions of one odorant were used the same way as described above for two different odorants. One concentration served as an “odor A” and the other as an “odor B”. A choice was provided between two concentrations of IAA diluted in paraffin oil. For purely practical reasons odorants were diluted in steps of 6:1 [ $\log_6$ ]. These steps are denoted as  $n_x$ , i.e. a dilution in 3 steps of 6:1 ( $6^3:1 = 216:1$ ) would be written as  $3_x$ .

It should be noted that the absolute concentrations of the odors in the air stream (molecules/volume) is not known. Concentrations of odors in the tubes correspond to the dilution prepared and filled into the odor cups placed on the end of training or test tubes. There was no measurement done regarding concentrations inside of the tubes. These values strongly depend on air flow within the machine and therefore absolute values in this study

cannot be directly compared with values in others experiments done in different apparatuses. On the other hand, ratios between different concentrations in our experiments should be constant. The same approach was used in other studies as well (Wang et al., 2003).

### **2.2.2 The Heat Box**

The conditioning apparatus was built in the workshops of the Würzburg Biocenter. Both an original and a modified version of the heat-box described by Wustmann and colleagues (1996) were used. The machine consists of an array of 16 chambers operated in parallel each with 4 peltier elements, 2 on top and 2 on bottom, which allow for fast heating and cooling. Each peltier element covers half the length of the chamber. Chamber size is of 26 mm length, 2 mm height, 4 mm width in the new version, while the chambers of the original heat-box are 40 mm long, 2.5 mm high and 4 mm width. Ulterior differences between the two version are temperature range during standard experiments, in the new machine from 25°C to 37°C while in the original one temperature varies from 18°C to 40°C. A control circuit and a thermo-sensor keep the chamber at a defined temperature. Glass side walls enable transmission and detection of an infrared LED source (which is invisible to the flies). While that light is detected by a directionally selective light gate in the original heat-box version, a bar code reader on the opposite side of the chamber detects it. The fly projects a shadow on a bar code reader (light gate array in Fig. 3) on the opposite side of the chamber. The position signal of the bar code reader is sent to the computer with a frequency of 10 Hz. Experiments were performed in complete darkness for the flies since they cannot detect red light. Chambers were cleaned with a pipe cleaner every day before and after experiments. Measurements were performed on at least four days to minimize effects of daily variability. The different groups in one graph were measured strictly in parallel.

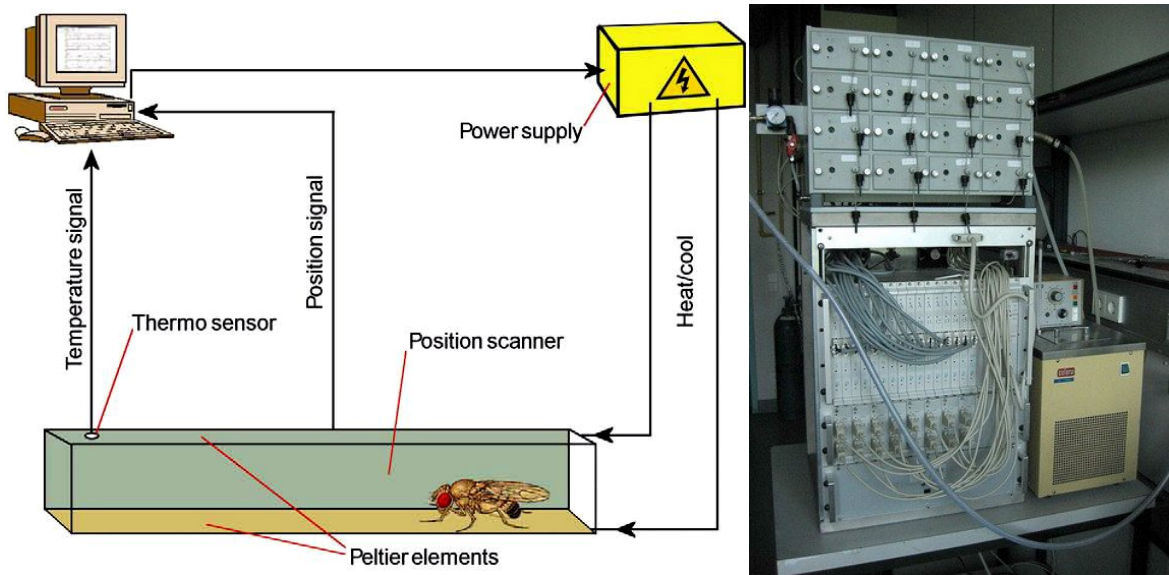
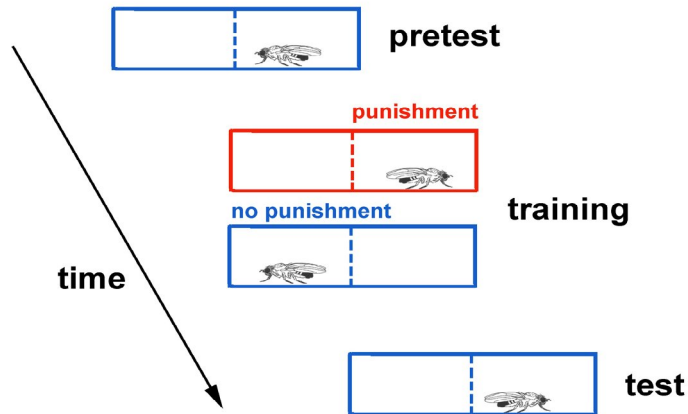

**Figure 2-3: Heat-box**

Schematic diagram of a single chamber (figure from Brembs, 2003, for details see text). On the right a picture of the whole experimental paradigm complete of the 16 chambers and the thermo-controlled water-bath on the side (for description see text).

### 2.2.2.1 Standard experiment

Conditioning in the heat-box is an operant process in which flies develop a spatial preference for one side of an experimental chamber. Single flies walking freely back and forth in a narrow alley in complete darkness, are conditioned to avoid one half (punished half) of the length of the alley by being heated instantaneously upon entering that half. The temporal scheme of heating and cooling simulates for the fly a spatial temperature gradient in the chamber. The training is followed by a test period without temperature change. During the whole experiment, the position of the fly in the chamber is monitored and the fraction of time the flies spent on the ‘unpunished’ side is calculated. Besides temperature, the fly can use only tactile information and path integration for orientation (ideothetic orientation, i.e. the accumulation of the internal representations of the fly’s turns and steps (Wustmann and Heisenberg, 1997)). One of the advantages of this paradigm is that the procedure is fast and robust, making it suitable for large-scale mutant screening. Additionally, learning scores are obtained automatically without the interference of an experimenter. A performance index is calculated by subtracting the time spent on the side associated with reinforcement from the time spent on the non-reinforced side and dividing this by the total time. Thus, a scale of -1 to 1 is generated with a total preference for the punished side giving a -1, and for the non-punished side a +1. These experiments were performed in the old version of the heat-box.

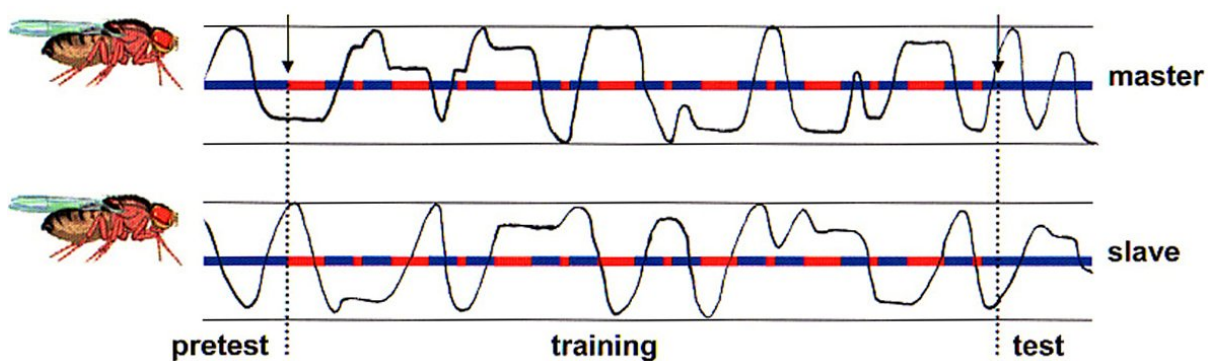

**Figure 2-4: The standard learning paradigm**

A fly is allowed to run in a small chamber that is heated to a defined temperature within seconds when it crosses an invisible midline; the chamber quickly cools to baseline (24°C) when it returns to the original side (figure from Zars and Zars, 2006). The baseline temperature of 24°C was used, as flies have a strong preference for this temperature over both higher and lower temperatures when given a prolonged choice (Sayeed and Benzer, 1996)

### 2.2.2.2 Idle experiment

A novel method to condition flies in the heat-box is the so called “Idle experiment”: a purely operant conditioning paradigm where flies are forced to increase their activity by punishment. Flies with equivalent activity levels were randomly assigned to either an escapable heat-shocked group (Master), an inescapable heat-shocked group (Slave) or an inescapable long term mild heat-shock group (Control). Flies from the different groups were introduced in either even or uneven numbered parallel chambers and after a period of acclimatization at the standard temperature of 24°C the training was started, flies were punished if they were not moving for a fixed amount of time with a heat shock of 37°C which was automatically stopped by the movement of the fly. During the test period which followed the training the heat shock was turned off.



**Figure 2-5: Idle experiment**

Schematic representation of the walking trace through time of a “master” fly and a yoked “slave” fly in their respective chambers. Notice that during the training the two flies are simultaneously punished (phases in red) when the master fly stops. Its movement ceases the punishment in both chambers (phases in blue). In the last test phase activity is measured.

The performance index was calculated by subtracting the period of inactivity of the Slave flies from the one of the Master flies normalizing the result by the length of the last test period. As an example, a P.I index of -0,1 would indicate that Master flies walked 10% more than Slave flies during the last test period. As flies are freely walking in the apparatus and are not damaged during the experiment, they can be used afterwards in further behavioral, histological or genetic investigations. These experiments and the subsequent standard experiment were performed in the new version of the heat-box.

### 2.2.2.3 Thermosensitivity assay

The thermosensitivity assay uses a chamber with peltier elements that can be independently controlled in the front and back half of the chamber (Zars, 2001). A reference temperature of 24°C is always kept in one half of the chamber, while the other half is stepped to 27°C , 30°C , 33°C , 37°C , 41°C , or 45°C. The side of the chamber set to the reference temperature changes after 60 sec, thus forcing flies to make decisions about their preferred temperature. All points in the chamber reach their final temperature within 1-2 sec. The Performance Index is calculated as described in the standard experiment.

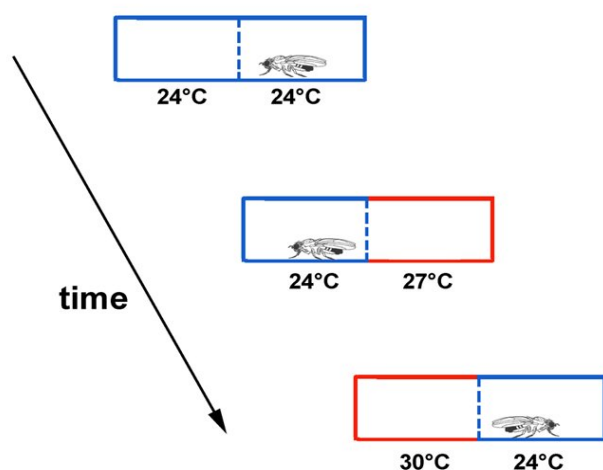

**Figure 2-6: Thermosensitivity test**

The thermosensitivity assay used the same chambers, but the temperature inside was altered independently of the flies' behavior. Individual flies were presented with a chamber that initially was at 24° C on both sides but then on one side increased to a probe temperature of 27° C and further to 30°, 33°, 37°, 41°, and 45° C , while the other chamber half was kept at 24° C. The chamber half with the lower temperature switched every minute. Flies were tested a total of 7 min. A performance index was calculated for this assay as in the learning assay (Figure from ???)

### 2.2.3 Statistical methods

In the case of the classical conditioning experiments reported in this work numerical confidence limits and error bars indicate standard errors of the mean. Sample sizes (n) for experiments using the learning index indicate the number of complete experiments. All between-group analyses were performed with repeated measures ANOVAs (Dunnett, 1955). The means were assessed by a two-sided Dunnett's test between means can be used to

compare a set of k-1 treatment groups against a control group, in this work the wildtype strain (CantonS).

Regarding the operant conditioning tests performed with the Heat-box to exclude animals which do not show substantial motor activity or do not experience punishment, the following criteria were established: flies had to walk at least one chamber length and get at least two heat exposures. For the standard experiments which followed the idle experiments, the subsequent additional criteria applied: After the transfer, flies had to walk one chamber length and had to experience at least one heat period to be included in the data set. As tests for normal distribution non-parametrical tests were used for statistical evaluation. Two independent groups were compared by Mann-Whitney U-tests. For comparison of three and more groups, Kruskal-Wallis ANOVA tests were used. Wilcoxon tests were applied to compare single Performance Indices to zero. Repeated measurements were evaluated with a repeated measures ANOVA. Error bars in the figures are SEMs; n indicates number of flies, in the idle experiments n indicates a pair of flies (Master and Slave). Statistically significant differences are shown in the graphs or mentioned in the text; \* =  $p < 0.05$ , \*\* =  $p < 0.01$ , \*\*\* =  $p < 0.001$ .

#### **2.2.4 Pharmacological treatment of flies**

Fluoxetine hydrochloride, Citalopram hydrobromide and 5-Hydroxy-L-tryptophan were obtained from Sigma (Product References: F132-10MG, C7861-10MG and H 9772-10MG). Pharmacological treatments consisted of feeding the drugs for 20 hr. The dosage was determined by literature information and preliminary trials. The drugs were freshly dissolved in a 5% sucrose solution. 2 paper stripes (11x2 cm) were soaked with 1,8ml of the final mixture, then crossed and pressed to the bottom and the sidewalls of a medium sized glass. Each glass held from 70 to 100 flies overnight.

#### **2.2.5 Molecular techniques**

Standard molecular methods such as PCR reactions and western blots were performed according to the methods described in Ausubel (1994).

### 2.2.5.1 Single fly PCR

Fly homogenates were generated by smashing single flies in 50  $\mu$ l SB and incubating the homogenates for 30 min at 37 °C. Proteinase K was then inactivated by heating to 95 °C for 1-2 min. The homogenates could be stored at 4°C for several months.

PCR reaction	Thermocycling program			
x $\mu$ l DNA (100 ng DNA) 41-x $\mu$ l H <sub>2</sub> O boil together for 5 min, chill on ice, spin briefly then add 1 $\mu$ l 2.5 mM MgCl <sub>2</sub> 1 $\mu$ l 2 mM dNTP 1 $\mu$ l primer (1pmol/ $\mu$ l) 1 $\mu$ l primer (1pmol/ $\mu$ l) 5 $\mu$ l 10x PCR buffer 50 $\mu$ l final volume	step	Temp	Duration	Cycle n.
	Denaturation	94,0°C	5min	1 cycle
	add 0.2 $\mu$ l Taq-Polymerase after 1 min			
	Denaturation	94,0°C	30 sec	26 cycles
	Annealing	50,0°C	30 sec	
	Elongation	72,0°C	1 min	
	Final Extension	72,0°C	5 min	1 cycle
	Final soak	4,0°C	$\infty$	

Table 2-1: Chemicals and program used for standard PCR reactions



## 3 Results

### 3.1 Olfactory conditioning in *S6KII* mutants

Previous studies showed that the performance of *ignorant* mutants in olfactory classical conditioning tests after a single training trial is anomalous and that *S6KII* contributes from 30 to 50 % to associative olfactory learning and memory at different retention intervals (Bertolucci, 2002). The complete loss of the *S6KII* coding sequence leads to an impaired memory after 3 min, 30 min and 3 hours, while performance of the *ignorant* P-element insertion mutant shows a memory retention level in between the performance of the deletion line and the wildtype, although the slight difference to the latter is not significant. A reduced amount of transcript in the P-element insertion line (see Figure 3-1A) might be sufficient to reach a learning performance indistinguishable from wildtype levels. The precise excision line *IP1* displays a fully normal performance at all three retention intervals, suggesting that the precise jump-out of the P-element reestablishes the normal *S6KII* function (Bertolucci, 2002).

#### 3.1.1 Characterization of transgenic lines

Still, these results do not represent a definitive prove in favor of a clear involvement of *S6KII* in classical conditioning, since the phenotype could be the result of an unknown “side effect” of the P-element insertion, whose removal could reestablish the normal behavior. As reported from Flybase, an online bioinformatic database of *Drosophila*, the *ignorant* gene is located in the intron of another gene of unknown function also located in the region 20C1 which is coded *CG17600*. Therefore the observed phenotypes could be the consequence of the disruption of this gene and not specifically of *S6KII*.

A genomic rescue of the phenotype was planned in order to assert a causal link between *S6KII* and the phenotype. Therefore a line was needed that would contain the genomic sequence of *S6KII* as a transgene.

Six independent transgenic lines were established by Putz (2004) inserting a P-element 6.5kb genomic fragment which contained a copy of the *S6KII* endogene in flies subsequently extensively cantonized. The chromosome where the plasmid inserted was localized using the balancer cross schema explained in the Materials and Methods section.

Chromosome		
1 <sup>st</sup>	2 <sup>nd</sup>	3 <sup>rd</sup>
	T1	
	T2	
		T3
		T4/1
T4/2		
		T5
T6		

**Table 3 -1: Transgenic lines**

The table indicates in which chromosome the plasmid inserted for the different lines used in this study. In 2 lines the plasmid inserted on the 1<sup>st</sup> Chromosome (T4/2 and T6), 2 lines on the 2<sup>nd</sup> (T1 and T2) and 3 on the 3<sup>rd</sup> (T3, T4/1 and T5).

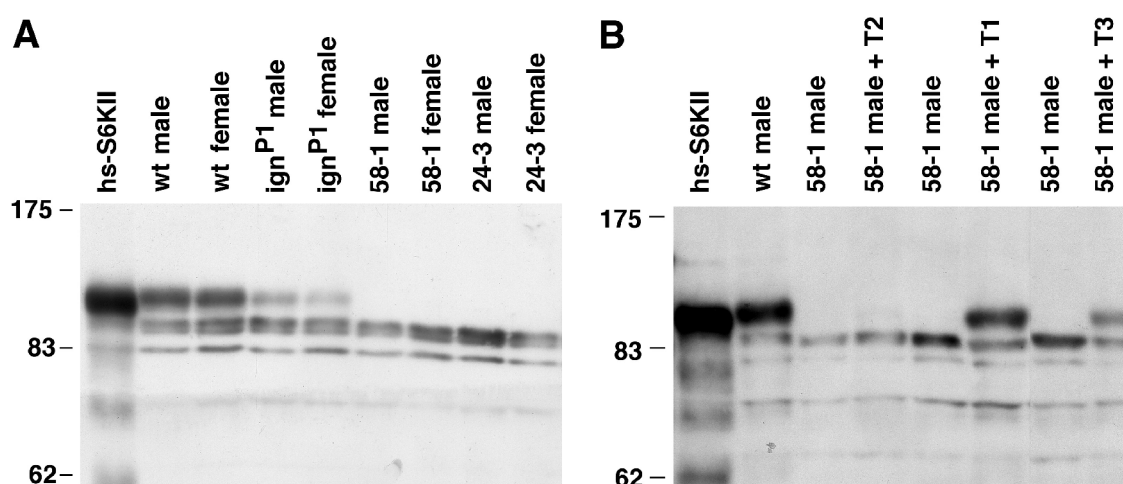
**Figure 3-1: Western blots of WT-CS and mutants**

(A) *S6KII* has a molecular weight of 90 kDa as witnessed by overexpression in *hsGAL4/UAS-S6KII* flies (left). This band has the same intensity in males and females of wild type and is equally reduced in both genders in the P-element line *ignP1*. The band is missing in the full deletion *Df(1)ign<sup>A58-1</sup>*, and the partial deletion *Df(1)ign<sup>A24-3</sup>* is missing the genomic sequence used for antigen production. (B) *S6KII* expression is restored in the male progeny of transgenic lines *T1–T3* crossed to mutant *Df(1)ign<sup>A58-1</sup>* females (e.g., *58-1 male+T1*). The bottom bands are unrelated proteins cross-reacting with the anti-S6KII-serum (figure from Putz et al., 2004).

The learning and memory defect of the complete deletion of the gene (*58-1*) was already known from previous studies (Bertolucci, 2002). Our goal was also to know if the partial deletion of the N-terminal region of the coding sequence could also lead to impairment in olfactory learning or if the still present C-terminal kinase domain is sufficient to perform normally in the Tully machine.

The odors used in all qualitative olfactory conditioning assays in this work were 3-octanol (OCT) or benzaldehyde (BEN), both undiluted and the retention time corresponds to the “standard” 3 minutes after training. All genetic lines were measured strictly in parallel through different days following a randomized sequence in order to avoid potential technical biases.

### 3.1.2 Genomic rescue of *S6KII* in olfactory conditioning

The *S6KII* expression rate detected in the line T1 made this the most suitable choice to try to rescue olfactory learning. Once the transgenic lines were mapped the T1 stock was crossed with both the deletion mutants *58-1* and *24-3* to confirm that the phenotype observed was due to the lack of *S6KII* in the organism.

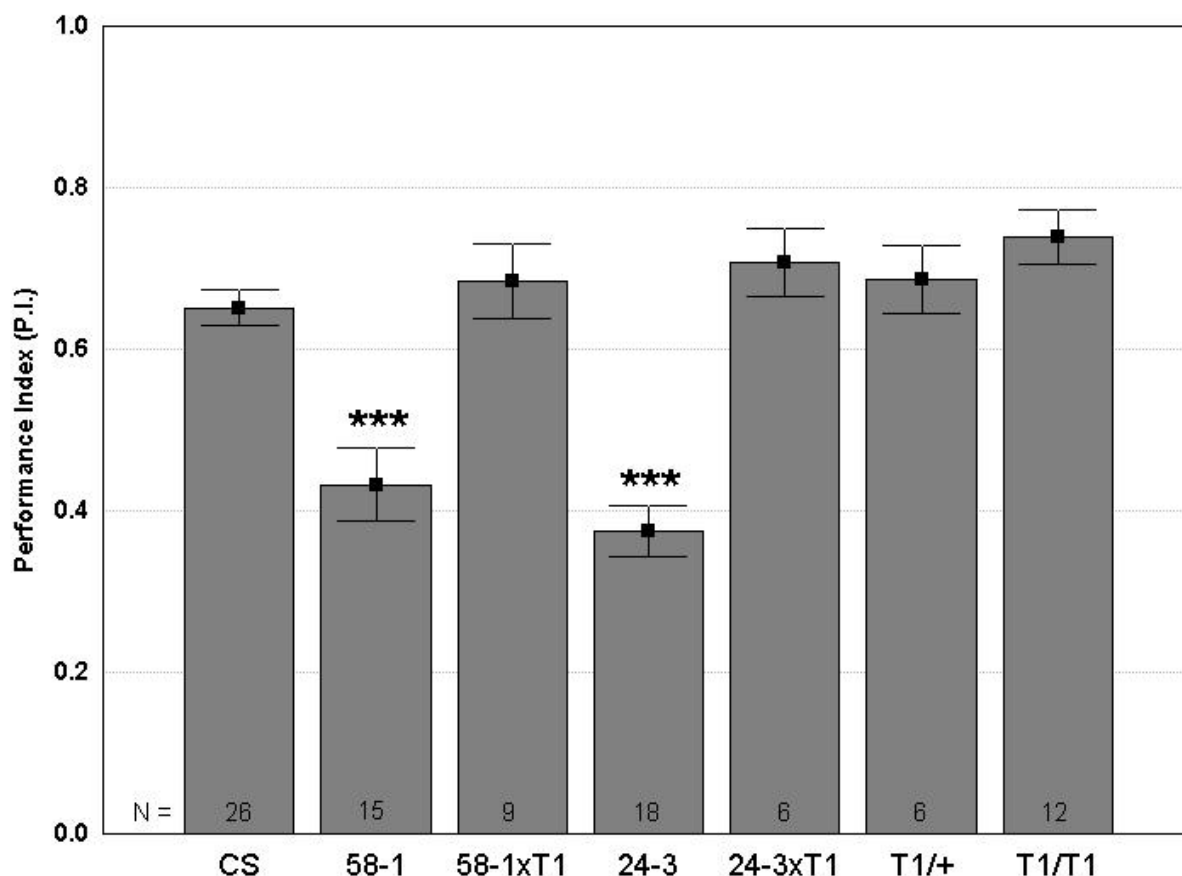

**Figure 3-2 : Genomic rescue in the Tully machine**

The null mutant *58-1* (Bertolucci, 2002) and the partial deletion *24-3* both display a decrement in olfactory learning after 3min retention time; the data display the performance of only males for technical reasons. A single copy of *S6KII* successfully rescued the defect in mutants *58-1* and *24-3* (\*\*\*) ( $p < 0,001$ , Bars represent mean PIs  $\pm$  SEMs). The memory index difference between the one extra copy line (*T1/+*) or the two extra copy line (*T1/T1*) is not statistically relevant ( $p > 0,05$ ).

The classical conditioning phenotype of the null deletion could be fully rescued by the transgene. The learning score of *58-1/Y; T1/+* males was significantly better than *58-1/Y* flies without the transgene and was indistinguishable from that of the *Canton S* control. Also the deleterious effect in *24/3* caused by the deletion of the N-terminal coding region of the gene could be fully rescued.

The genomic rescue unequivocally showed, as like assumed in previous studies (Bertolucci, 2002), indeed not only place learning in the heat-box (Putz et al., 2004) but also

olfactory conditioning in the Tully machine depends on the presence of an intact *S6KII* gene and it is not a negative side-effect caused by the disruption of neighboring genes (Figure 3-3).

### 3.1.3 Heterozygous *S6KII* mutants in olfactory conditioning

Both mutants, the null deletion *58-1* and the partial deletion *24-3*, were tested for 3 min olfactory memory after being crossed with *CS* in order to investigate if the phenotype could be dominant or recessive. Since the mutation is located on the X-chromosome this time only females are shown.

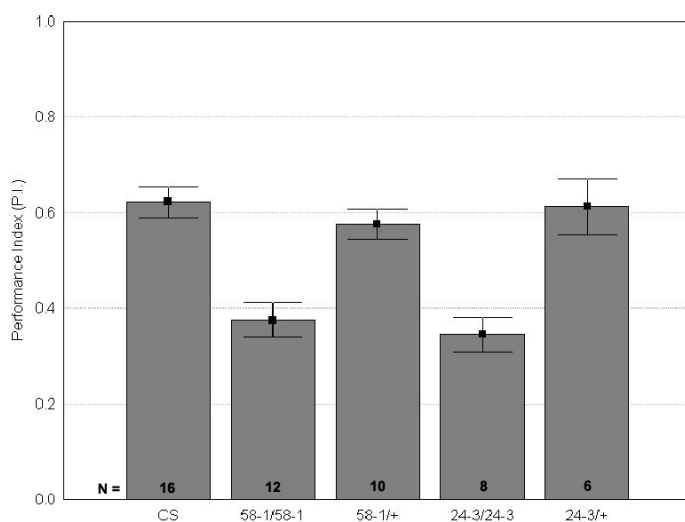

**Figure 3-3: Heterozygous *58-1* and *24-3* in olfactory learning**

The full deletion *58-1* and the partial deletion *24-3* both display normal olfactory learning after 3min retention time ( $p < 0,05$ ). The data display the performance of only females because the mutation is located on the X-chromosome. A single copy of *S6KII* is sufficient for flies to perform as wildtype. The presence of the truncated protein in *24-3/+* heterozygous is not deleterious in this task.

Heterozygous *58-1/+* and *24-3/+* flies showed a normal 3 min olfactory memory, not significantly different from that of the wildtype control and were better performing than the respective homozygous lines (Figure 3-4). Therefore a dominant effect could be definitely excluded for both phenotypes.

### 3.1.4 Overexpressing transgenic lines in olfactory conditioning

Interestingly, during the first trials of this experiment, homozygous flies of the transgenic line *T1* carrying two extra copies of *S6KII* showed a slightly but consistently improved performance in olfactory memory compared to wildtype (in Figure 3-5 the PIs for CS and T1/T1 flies are still significantly different if only these are compared). It had been reported that *Drosophila* can be genetically manipulated to perform better in olfactory learning than wildtype. For example flies after induction of atypical DaPKM activity could show an enhanced long term memory in classical conditioning (Drier et al., 2002). DaPKM, a

*Drosophila* homolog of  $\text{MaPKM}\zeta$ , which is abundant in *Drosophila* heads and is necessary for normal long term memory. Heat-shock overexpression enhanced it.

Both *DaPKM* and *S6KII* are kinases which are phosphorylated by *PDK* and support synaptic plasticity in *LTP*. Therefore, I tested if, similarly to *DaPKM*, an increase of *S6KII* expression could lead to a memory enhancement.

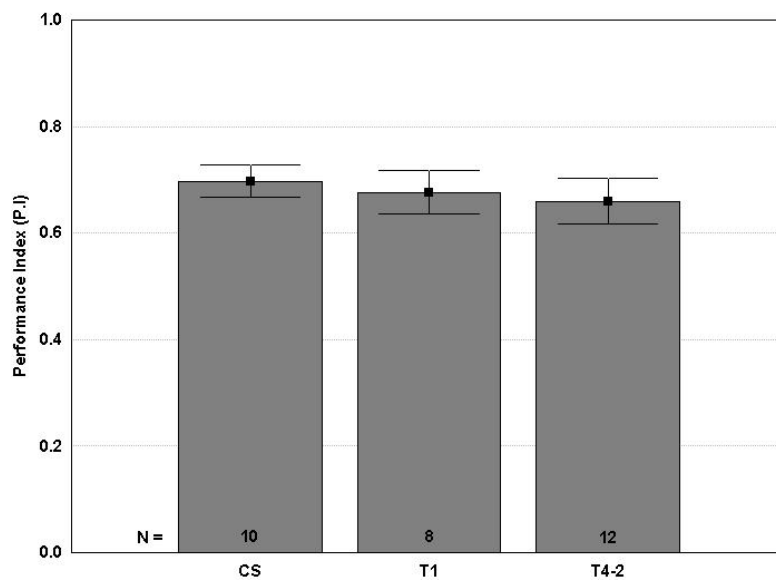

**Figure 3-4: Transgenic lines in classical conditioning**

Olfactory associative learning in transgenic lines overexpressing the *S6KII* gene failed to reproduce the initial hint that an overabundance of *S6KII* in the organism might lead to an increase in the memory score. Memory scores of *T1* and *T4-2* lines are not different from the one of wildtype ( $p < 0,05$ ).

In addition to the 2<sup>nd</sup> chromosome-line *T1* I investigated the X-chromosomal insertion *T4-2*. The data (Figure 3-4) did not reproduce this original observation. A possible explanation may be selection of dosage-dependent modifiers (de Belle and Heisenberg, 1996) in the meantime.

### 3.1.5 Rescue via temporal expression of *S6KII*

The genomic rescue could establish that *S6KII* was responsible for the learning phenotype in the classical conditioning paradigm, but it could not exclude that this effect was a consequence of a developmental defect rather than a direct consequence of the lack of the kinase in the associative process. To determine the time of action of the enzyme a temporal rescue of *S6KII* was performed using the temperature sensitive *hs-GAL4* as driver (reviewed in Duffy, 2002) and a *UAS-S6KII* effector friendly provided by Prof. E. Hafen. Until they hatching from the pupal case flies were raised at the restrictive temperature (25°C) in order to avoid any protein expression during development. Adult flies were collected and divided in two groups. One group was exposed to the temperature shock for 30 min (35 °C twice a day),

for 3 consecutive days; see effect of this induction in Western-Blot in Figure 3-1. After a rest period of 30 minutes flies were tested in the Tully apparatus with standard procedures. Following the rationale of the crossing scheme, again only male flies were evaluated for PIs.

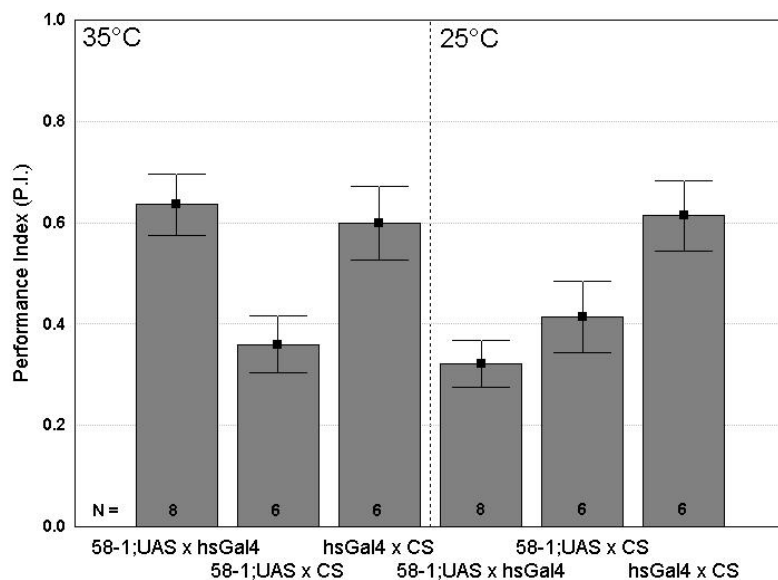

**Figure 3-5: Temporal rescue of the olfactory conditioning phenotype**

Adult flies containing the heat shock GAL4 driver, the UAS-S6KII effector and the 58-1 mutant were able to perform normally in the standard olfactory conditioning test if previously exposed to the heat shock as adult, indicating that restoring *S6KII* after development produced a full rescue of the learning impairment of the mutant. Performance of only males is shown.

The olfactory memory defect of the null mutant could be rescued after heat shock. *58-1/Y; hsGAL4/UAS-S6KII* males exposed repetitively at 35°C learned significantly better than the negative control *58-1/Y* (35°C) and better than the flies obtained by the same crossing scheme but kept at low temperature (*58-1/Y; hsGAL4/UAS-S6KII*; 25°C). Thus, the lack of the kinase during development is not responsible for the impairment in olfactory conditioning in the adult phase, suggesting an active role of the S6KII kinase in learning and memory formation.

### 3.1.6 Local rescue of *S6KII* in olfactory conditioning

One of the ambitions in memory research has always been to localize memory traces in the brain. Several attempts have been made with the most different techniques like surgical ablation or by mapping necessary gene expression in transgenic animals (Heisenberg, 1998). Using the GAL4/UAS system in the mutant *58-1* it was thus determined where in the central nervous system the kinase is needed for rescue of the olfactory learning phenotype. In the first attempt *elavGAL*, a pan-neuronal driver was used. This experiment was of key importance to clarify whether S6KII was needed in neurons or in cells outside the nervous system.

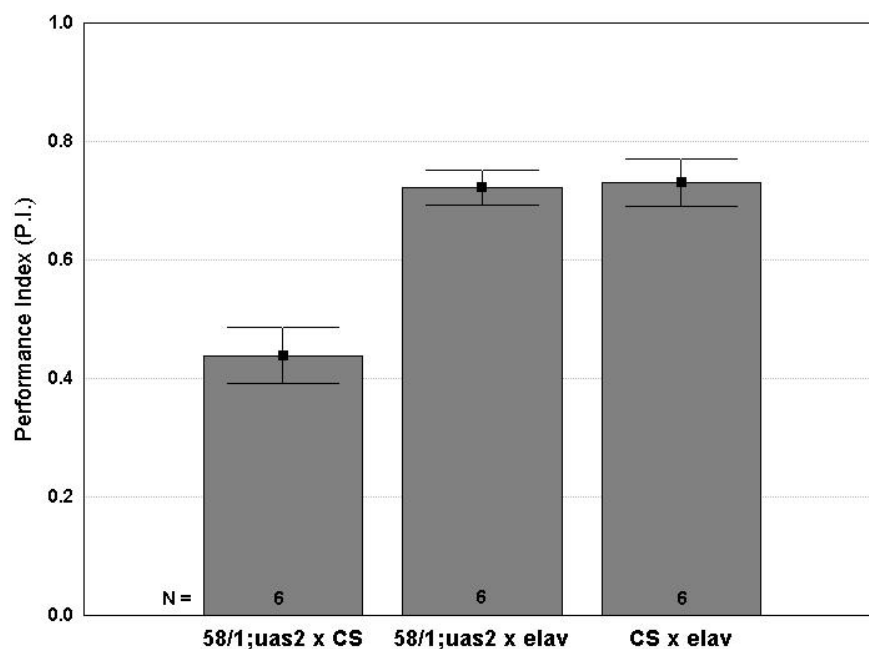

**Figure 3-6: Spatial rescue using *elav-GAL4* driver**

Pan-neuronal expression of *S6KII* in *Drosophila* nervous system successfully rescues the olfactory learning and memory defect of null mutant ( $N \geq 6$ ,  $p < 0,001$ ). Performance of only males is shown.

The olfactory learning defect of the *S6KII* null mutant was rescuable with *elavGAL4/UAS-S6KII*. This confirmed the hypothesis that S6KII is involved in neuronal processes which facilitate learning and memory formation. After this first successful try using a broadly expressing pan-neuronal driver, more specific GAL4 lines were chosen.

Restoring S6KII in a defined set of neurons in a spatially restricted way provides its function in classical conditioning memory to only those specific cells. If in such flies a learning task is rescued, the corresponding memory trace is said to be mapped to the set of neurons expressing the gene.

In the respective “classic” learning and memory mutants, *dunce*, *rutabaga* and *DCO* proteins are expressed at elevated levels in the mushroom bodies (Nighorn et al., 1991; Skoulakis et al., 1993). Besides, since mushroom body less flies fail in olfactory conditioning and not in some other tasks, this pair of neuropil structures in the central brain stands for one of the main regions of interest for how odorant information is coded and stored in flies (de Belle and Heisenberg, 1994; Connolly et al., 1996; Heisenberg, 1998; Wolf et al., 1998). So far, no functional evidence indicates that S6KII phosphorylation was required within mushroom bodies to mediate classical conditioning. Therefore *mb247GAL4*, a mushroom body specific *GAL4* line (Zars et al., 2000) was chosen as driver, combined with 2 lines containing a *UAS-S6KII* insertion either on the 2<sup>nd</sup> (*UAS2*) on the on the 3<sup>rd</sup> chromosome (*UAS3*).

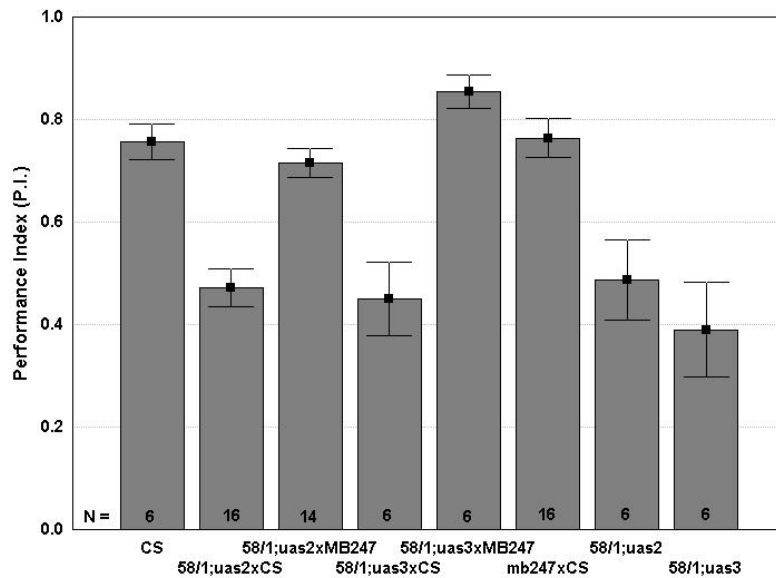

**Figure 3-7: Mushroom body rescue of *S6KII* in classical conditioning**

Mushroom body expression of wildtype cDNA rescues the *ignorant* learning and memory phenotype. Performance indices of null mutant flies with both the *mb247GAL4* driver and the *UAS*-construct display a normal performance index, not statistically different from the control flies (CS,  $p > 0,05$ ).

The *UAS* constructs in the null background in absence of the driver could not improve the *S6KII* mutant phenotype. These lines showed the defect in both CS-crossed or homozygous status ( $p < 0,001$ ). Performance of only males is shown.

The rescue of the olfactory learning defect in mushroom body specific driver line was complete and the performance indistinguishable from that of control flies (Figure 3-7). These results showed that *S6KII* expression is needed in the MBs to reestablish normal olfactory memory. A similar effect had previously been obtained with other classical conditioning mutants like *rutabaga*, a gene coding for a type I  $Ca^{2+}$ /calmodulin-dependent adenylyl cyclase (AC) which regulates the synthesis of cyclic adenosine 3',5'-monophosphate and is known to play an important role in learning and synaptic plasticity (Tully and Quinn, 1985; Zars et al., 2000).

The mapping process using the *GAL4/UAS* system can ultimately be pushed to the single neuron level. In the present context, however, it is limited by the available *GAL4* lines to subsets of cells. Therefore, following the example of studies on *rutabaga* (Zars et al., 2000) three other *GAL4* lines were selected for local rescue due to their expression pattern (see Figure 3-8). Furthermore, a comparison between the rescue results of *rutabaga* and *S6KII* mutants could reveal an overlap of the structures necessary for the rescue of the olfactory conditioning phenotype of the two proteins suggesting a hypothetical concurrence in the same signaling pathway.



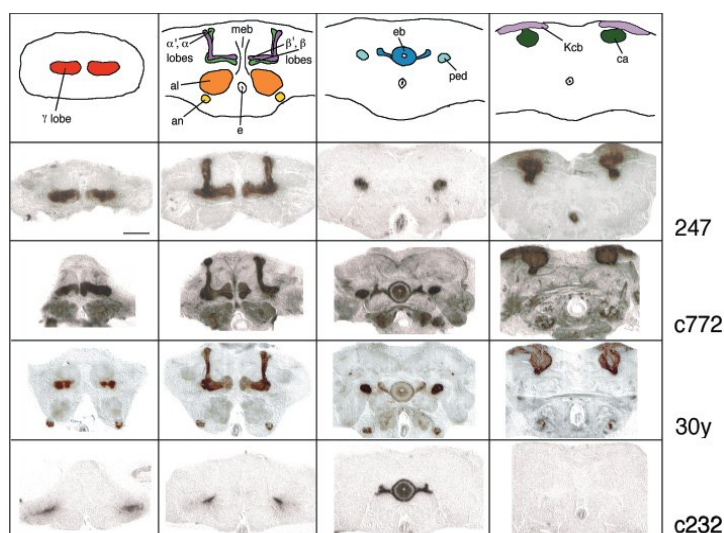
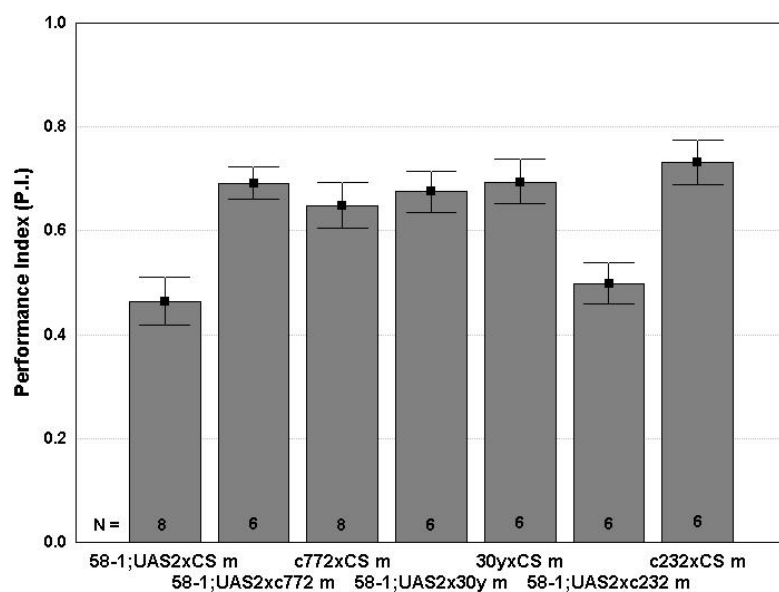

**Figure 3-8: Spatial expression of *GAL4* lines used for rescue experiments**

In the schematic drawing of a frontal brain section several structures can be recognized: the  $\gamma$ -lobes,  $\alpha/\beta$ ,  $\alpha'/\beta'$  lobes, median bundle (meb), ellipsoid body (eb), peduncles (ped), and calyces (ca).

The first 3 lines rescued the *S6KII* odorant learning defect and showed common expression in the mushroom bodies. *C772* and *30y* show expression also outside the mbs, namely in the eb, in the antennal lobes and in the fan-shaped body (not shown). The *c232* line did not rescue the *S6KII* phenotype and its expression pattern was restricted to the eb (from Zars et al., 2000). Scale bar, 50  $\mu$ m

This time only one *UAS-S6KII* line (*UAS2*) was used.



**Figure 3-9: Olfactory learning of *S6KII* mutant is rescued by local transgenic expression of wildtype gene**

The performance of *S6KII* null mutant flies carrying only the *UAS-S6KII* p-element show the mutant defect.

As already with the *mb247GAL4* driver, the lines *C772* and *30y* both successfully rescued the olfactory learning phenotype, while no significant difference was observed between *58-1;UAS2* flies in presence or absence of the *c232GAL4* driver. All heterozygous *GAL4* lines performed normally. Only males are shown.

The lines *C772* and *30y* both successfully rescued the olfactory learning phenotype, while no improvement was observed for mutants which had the *c232GAL4* driver in combination with the *UAS2* P-element transgene. These flies showed a similar performance as *S6KII* null mutant flies.

Neither the rescuing nor the non-rescuing *GAL4* enhancer trap inserts showed a negative effect on wildtype performance. The defect of the original null mutant and of the rescue attempt with *c232GAL4* were not attributable to lack of shock sensitivity or odor perceptivity since the olfactory and shock controls revealed a normal shock reactivity and odorant avoidance.

The expression patterns shown in the serial sections of Figure 3-8 help to interpret the behavioral data in order to determine which brain structures are sufficient for olfactory memory: it is evident that the main structure, which is labeled in all rescue lines are the mushroom bodies. Furthermore, confronting the expression patterns and the performance of lines 247, 30y and c772 to c232 it can be affirmed that structures like the median bundle and the ellipsoid body are not structures where *S6KII* is required for olfactory learning and memory.

### 3.1.7 *Rutabaga-ignorant* double mutants in olfactory conditioning

The facilitation of mushroom body-based synaptic plasticity, frequently investigated in model learning paradigms such as the Tully machine, is associated with several cellular key events: generation of cyclic AMP (cAMP) and activation of protein kinase A (PKA), phosphorylation of mitogen-associated protein kinase (MAPK), activation of cAMP-response element-binding protein (CREB) by *S6KII*, and subsequent transcription of neuronal plasticity-associated genes. Although this widely accepted model implies a tight interaction between the cAMP signaling cascade and the MAPK kinase cascade, a behavioral confirmation of the interdependence between *S6KII* and *rutabaga* still has not been provided.

The spatially specific rescue experiments previously described suggested a correspondence between the necessary structures for *S6KII* and *rutabaga*-dependent olfactory memory. Consequently it was planned to create via recombination an *S6KII -rutabaga* double mutant in order to study the effect of the absence of both genes on classical conditioning. A non-additive suppression of learning by the double-mutant in the Tully machine experiment would give further credit to the hypothesis that *S6KII* and *rutabaga* contribute through the same pathway to olfactory memory. On the other hand, an additive effect would suggest that they act on parallel cascades and that the disruption of both of them leads to a worse defect than to the ones caused by the single mutations.

130 single crosses were set up following the crossing scheme explained in the Materials and Methods section and produced an offspring of 32 potential double mutants. These were subsequently tested by polymerase chain reaction (PCR) for the *58-1* deletion and for the *rutabaga*<sup>2080</sup> P-element insertion. As expected 3 lines (statistical recombinant calculations predicted one tenth of the progeny) resulted positive for both mutations. These lines were catalogued with the numbers 2, 10, 32 and tested for olfactory conditioning.

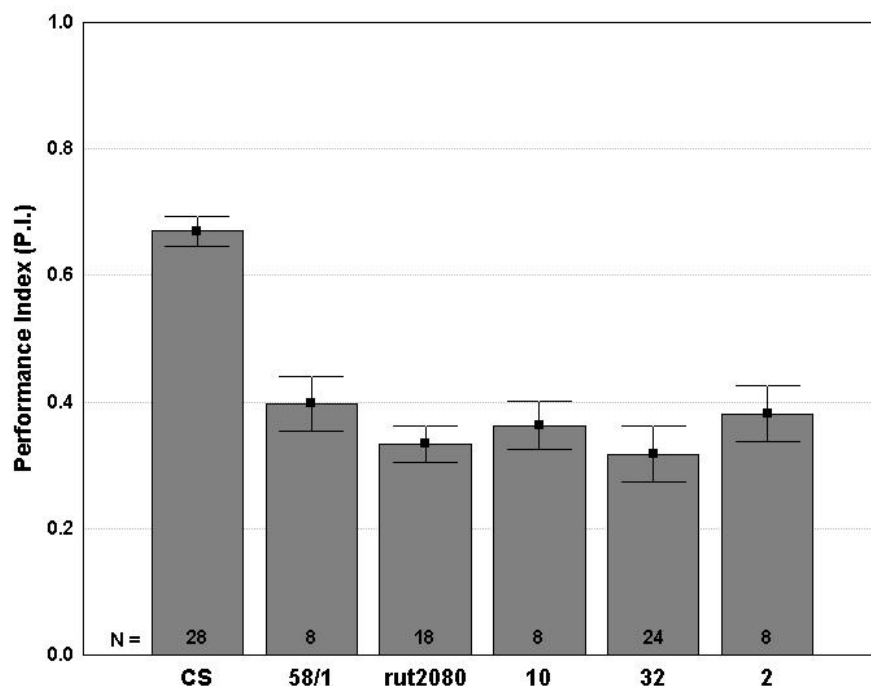

**Figure 3-10: Olfactory conditioning of single and double mutants for *S6KII* and *rutabaga***

The performance indexes of *58-1* and *rutabaga*<sup>2080</sup> single mutations are indistinguishable from each other. Interestingly the mutants containing both mutations (lines 10, 32 and 2) display a defect which is perfectly comparable to the ones of the single mutations ( $p < 0,05$ ).

Mutants which carried both *S6KII* null deletion and *rutabaga* P-element insertion on the X-chromosome showed a performance undistinguishable from the one of the single mutations, therefore corroborating the hypothesis that both proteins are involved in subsequent steps of the same biochemical pathway responsible for olfactory learning.

### 3.1.8 RNAi mediated *S6KII* expression silencing in olfactory conditioning

An alternative technique to interfere with gene expression, is RNA interference (RNAi) or post-transcriptional gene silencing (PTGS) initiated by the introduction of double-stranded RNA (dsRNA). This technique has been currently established in *Drosophila* and several other organisms like *Caenorhabditis elegans*, plants, and recently, in mammalian cell cultures. In flies, dsRNA, introduced by transgenic elements, triggers the natural degradation of a complementary mRNA, silencing in that way partially or completely the targeted gene (reviewed in Geanacopoulos, 2005).

An attempt with the RNAi against *S6KII* was performed to reproduce and better understand the results obtained with the previously described techniques in order to dissect more deeply the neuronal network where *S6KII* is required for classical conditioning. Flies containing insertions with the *S6KII*-dsRNA under UAS control were kindly provided by K. Keleman and were subsequently crossed to a pan-neuronal GAL4 line, *nSyb* and a MB specific line *mb247*. The progeny was then tested for olfactory conditioning.

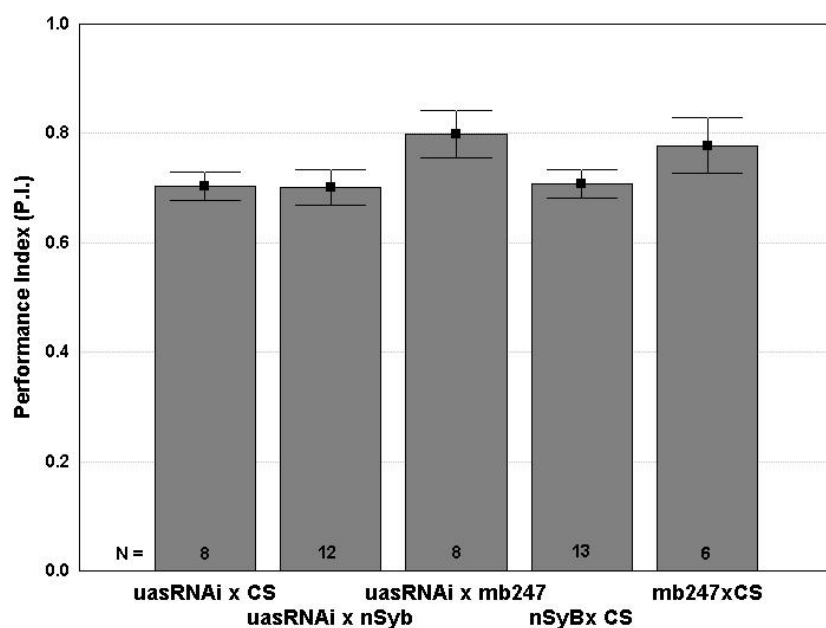

**Figure 3-11: RNAi mediated silencing of *S6KII* expression in olfactory conditioning**

Pan-neuronal or mushroom body specific expression of *S6KII*-dsRNA fails to mimic the *S6KII* memory phenotype. PIs of flies with *nSyb-GAL4* or *mb247-GAL4* driven dsRNA-*S6KII* expression display a normal performance index, not statistically different from the control groups ( $N \geq 6$ ,  $p > 0,05$ ).

Unfortunately, the RNAi technique did not produce the desired results. Both *nSyb*- and *mb247-GAL4* drivers failed to mimic the *S6KII* null mutant phenotype, perhaps because of an insufficient amount of dsRNA which led to a residual amount of *S6KII*, which was enough for normal olfactory learning. Similar failures have been reported for other adult neuronal systems (personal communication, citation needed).

### 3.1.9 Odor intensity learning in olfactory conditioning mutants

A novel short term memory called odor-intensity memory has been proposed, which has different properties from odor quality memory. The definition of odor intensity learning is “an association between an odor concentration, independently of its quality, and an external stimulus”. It has been shown that odor intensity learning is *dunce* and *rutabaga*-independent (Mašek, 2005), implying that the defect of *rutabaga* mutants in olfactory classical conditioning is due solely to odor-quality learning. So far no odor intensity learning mutant has been identified. It was therefore tested whether the *S6KII* mutant displayed a defect in odor-intensity learning, as suggested by preliminary studies.

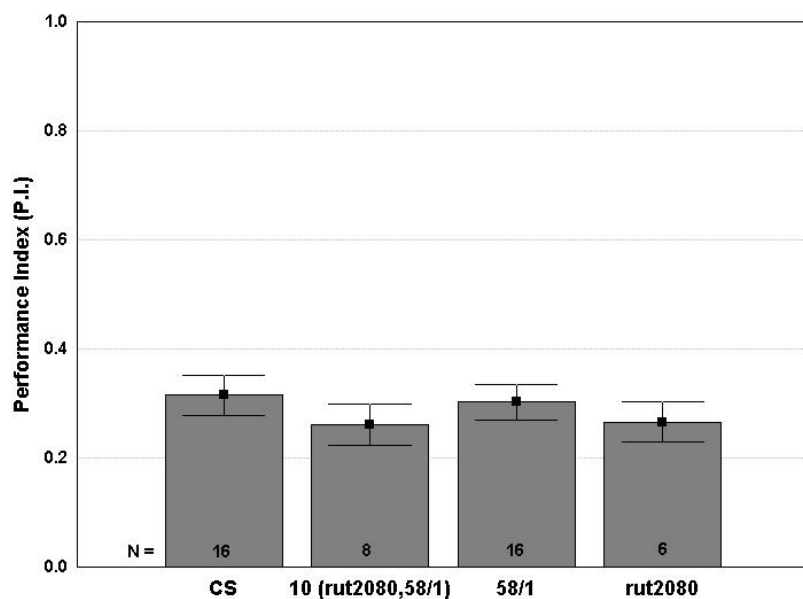

**Figure 3-12: Odor-intensity learning in *S6KII* and *rutabaga* mutants**

Odor-intensity learning is independent from the *S6KII* and *rutabaga*. If tested for short-term memory, a combination of both mutations in one mutant line leads to an unaltered performance index. The odorant (IAA) relative ratio was 1:6. This implies that concentration learning does not depend on cAMP pathway or either MAPK kinase cascade.

Two concentrations of isoamyl acetate (IAA) at the ratio 1:6 were used. For *rut* the mutant *rut<sup>2080</sup>*, and for *S6KII* mutant *58-1* were chosen. Both mutants performed as well as WT flies and at the same level was the performance of the double mutant (line 10) containing both mutations. It is concluded that odor-intensity learning does not require *S6KII*, in line with the assumption that *S6KII* is involved in the same signaling pathway as *rut* and *dnc*.

### 3.2 *S6KII* mutants in the heat-box

The *ignorant (ignP1)* mutant was originally discovered through a screening procedure of a collection of P-element insertion lines provided from Dr. Ulrich Schaefer (Max Planck Institute in Göttingen). This screening was performed by G. Putz (2004) with the heat-box, an apparatus used to test flies for place learning. In this machine both genders of the precise excision line *ignΔIP1* performed poorly in operant conditioning. Moreover, excision of the P-element reverted the defect of *ignP1* flies to wild type.

Also males and females of the partial deletion line *24-3* showed a place learning defect, which turned to be dominant. Surprisingly the null deletion *58-1* performed normally proving that the removal of the complete coding region did not influence place learning and that the gene is not essential for this task. All mutants were positively tested for normal thermosensitivity (Putz et al., 2004).

### 3.2.1 Transgenic flies in the heat-box

After being tested on Western Blot for *S6KII* expression, all the transgenic flies including the stock used for the olfactory learning genomic rescue (*T1*) were tested for place learning in the heat-box.

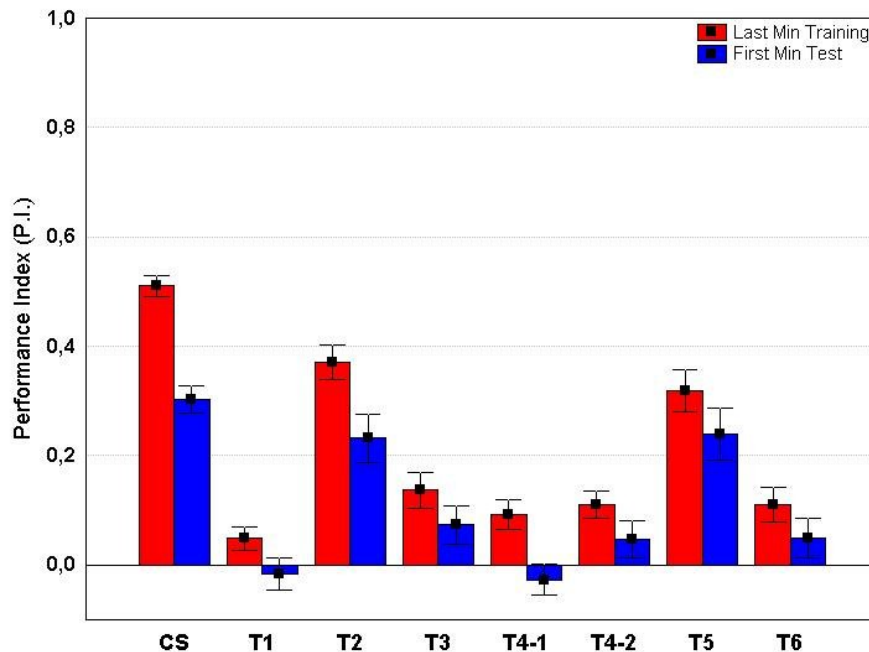
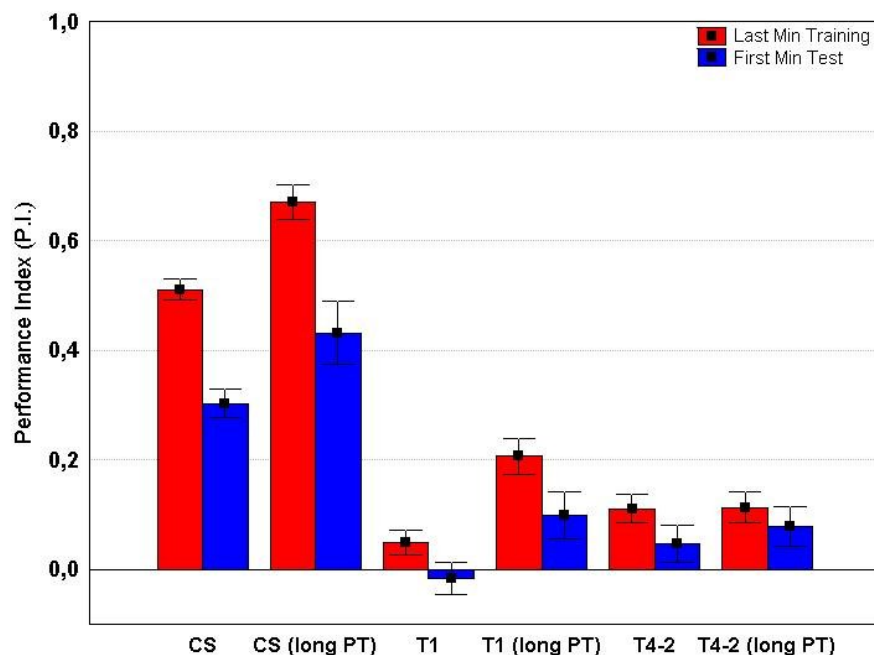

**Figure 3-13: Place learning of transgenic mutants**

Heat-box learning of homozygous overexpressing transgenic lines, males and females together. Performance of the last minute training and first minute test is shown. All lines showed a reduced performance ( $p < 0,05$ ).

All seven transgenic lines carrying 2 extra-copies of *S6KII* showed a decrement of performance, in some of them (*T1*, *T3*, *T4-1*, *T4-2*, *T6*) the impairment was astonishingly severe. Comparing the performance of lines *T1* to *T3* with the expression levels detected on the Western Blot of the same lines (Figure 3-1B) one notices a negative correlation between the expression level and place learning: the higher the level of *S6KII*, the smaller the PI.

In the heat-box high walking activity reduces the performance index. As activity in the heat-box sharply declines in the first few minutes, we wondered whether PIs of transgenic lines would increase if flies were allowed to settle down in the chamber before measurement. Therefore flies were introduced in the respective chambers and left to rest for 5 minutes before training.



**Figure 3-14: Prolonged pretest effect on wildtype and transgenic lines performance**

Comparison of performance of CS and two transgenic lines without and with 5 minutes of pretest. The period of rest contributed in some cases to an improvement of performance ( $p > 0,05$ ), while the gap between CS and both transgenic lines remains unaltered. Values of CS, T1 and T4-2 are taken from figure 3-13 as comparison.

As expected the longer accommodation in the chambers before the conditioning training led to better performance of wildtype and of the T1 transgenic line. Surprisingly this did not happen for T4-2 whose performance remained unaffected. Nevertheless the comparison between CS and transgenic lines revealed that even at a lower activity level, the PI of the overexpressing mutants was still drastically reduced. As these alterations of activity were much larger than the activity increase in the transgenic lines, it was assumed that activity was not the main cause of low learning memory.

### 3.2.2 Rescue of the phenotype in the heat-box

The behavior of *S6KII* mutants in the heat-box and in the Tully-machine could hardly be more different. In place learning the transgenic lines carrying double the amount of gene sequence are performing poorly and the null mutant shows no phenotype, while in the olfactory learning paradigm the situation is inverted. Nevertheless a similar strategy to the genomic rescue utilized in the classical conditioning test could be used in the heat-box learning paradigm. To verify that indeed the excess of *S6KII* was responsible for the place learning defect of the transgene lines, *T1* was crossed to the null mutant *58-1*, in order to create a progeny which had reverted to a normal number of copies of *S6KII* sequences. In fact the resulting *58-1;T1* line was carrying both the excision of the gene and a genomic copy inserted on the second chromosome. These flies were then tested for the standard heat-box experiment.

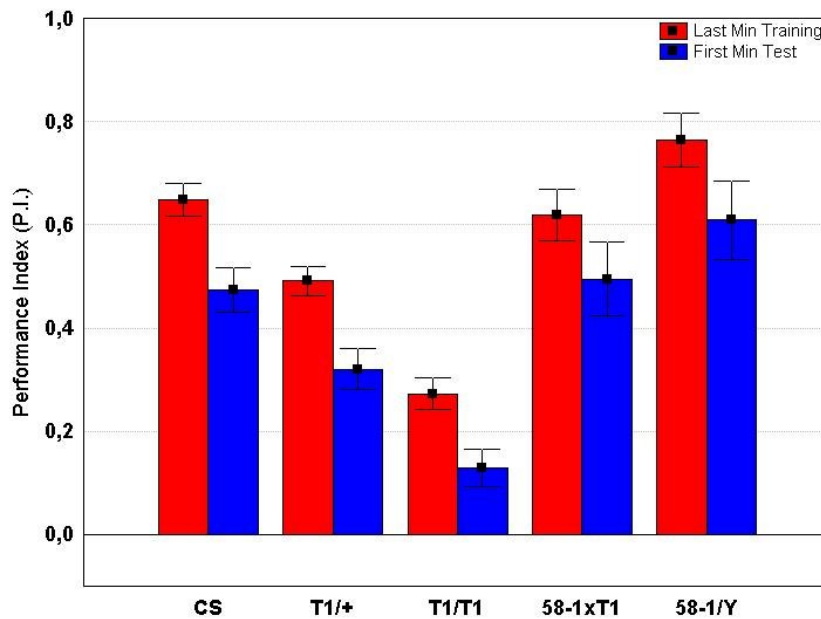

**Figure 3-15: Transgenic line phenotype rescued in the heat-box**

Memory defect of transgene line *T1* is shown; interestingly the defect is reverted to normal in the line *58-1xT1* in which the normal genomic amount of *S6KII* was restored.

*T1/+* males carrying a single dose of *S6KII* as a transgene showed a performance between the positive control Canton-S and the homozygous transgene line.

In this experiment the effect of the overexpression of *S6KII* on heat-box learning was not as disrupting as in the previous one (see figure 3-13), but the defect persisted and interestingly the effect was dose dependent: a single copy of the transgene (*T1*) still disrupted learning in the heat-box although not as drastically as in the homozygous stock with two copies.

Crossing *T1* to the null mutant *58-1* generated *58-1/y*; *T1/+* males which carried a single dose of *S6KII*, although on the second chromosome as a transgene. These flies performed normally, similarly to wildtype flies and significantly better than *T1/+* males with two copies of *S6KII*. This demonstrates that loss of the endogenous *S6KII* gene can compensate for the dominant negative effect of the transgene. Hence it is likely that the learning defect has its origin in the high dosage of *S6KII*.

### 3.2.3 Effects of local overexpression of *S6KII* in operant conditioning

Localizing structures which contain memory traces can be performed not only by reestablishing gene expression in selected structures in order to rescue the phenotype (explained in the paragraph 3.1.6), but also by trying to disrupt learning by locally interfering with its molecular components.

The results previously presented constitute evidence for the hypothesis that the defect in place learning of *S6KII* is determined by concentration anomalies; therefore it was tempting to try to re-establish a memory-disruptive high concentration of *S6KII* in selected



structures of the fly brain and see if it was possible to recognize an effect similar to the one seen with the transgene lines. Therefore both UAS insertion lines were crossed with *elavGAL4* and tested for place learning.

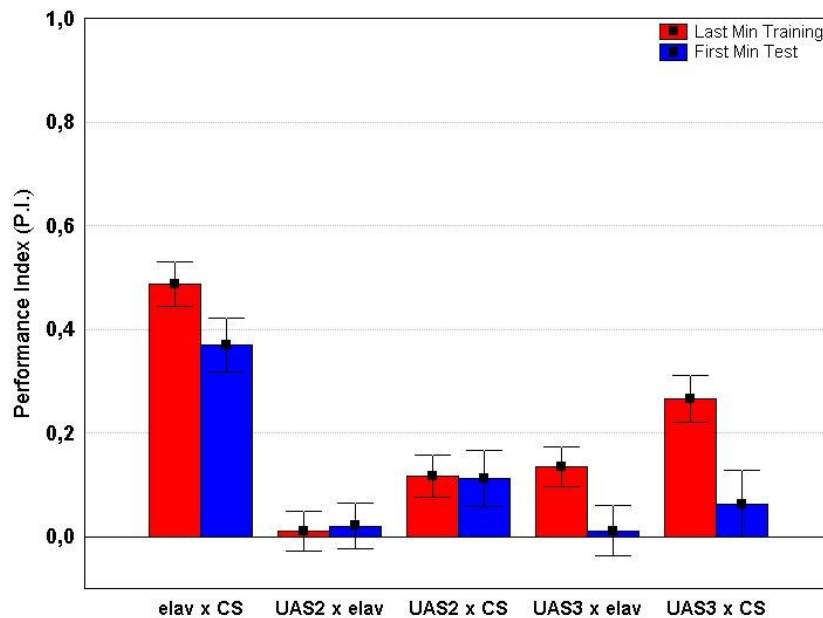

**Figure 3-16: Heat-box performance of *elav* driven overexpression in *S6KII* mutants**

Abnormal *S6KII* levels in flies leads to defective learning and memory in the heat-box. Local overexpression in the neurons of the fly seems to replicate this deficit, although the control lines (*UAS2xCS* and *UAS3xCS*) perform poorly as well. Performance of the UAS effector lines is not statistically different ( $p > 0,05$ ) in presence or in absence of the driver insertion.

Interestingly the drastic defect observed in most of the transgenic lines in place learning was paralleled by targeted overexpression of *S6KII* in neurons. Unfortunately, however, the UAS reporter line alone, without the driver insertion displayed a similar negative effect. A possible explanation could be that this effect is caused by leakiness of the reporter insertion which expresses the product of UAS-*S6KII* also in the absence of a specific driver. Therefore it remained unclear whether *S6KII* overexpression in neurons could suppress place learning, though extremely plausible.

### 3.2.4 Double mutant *rut,58-1* in the heat-box

The learning mutant *rut*<sup>2080</sup> is impaired in heat-box conditioning (Zars et al., 2000) and it is known that expression of wildtype *rut* cDNA in specific structures like the median bundle, antennal lobes, and ventral ganglion is sufficient for rescue of *rut*-dependent place memory. A link between *rutabaga* and *S6KII* could already be established in olfactory learning where the double mutant displays a non-additive defect (see figure 3-17). It was not obvious whether the same relationship would apply to place conditioning. Therefore, it would be interesting to investigate how this double mutant performs in the heat-box.

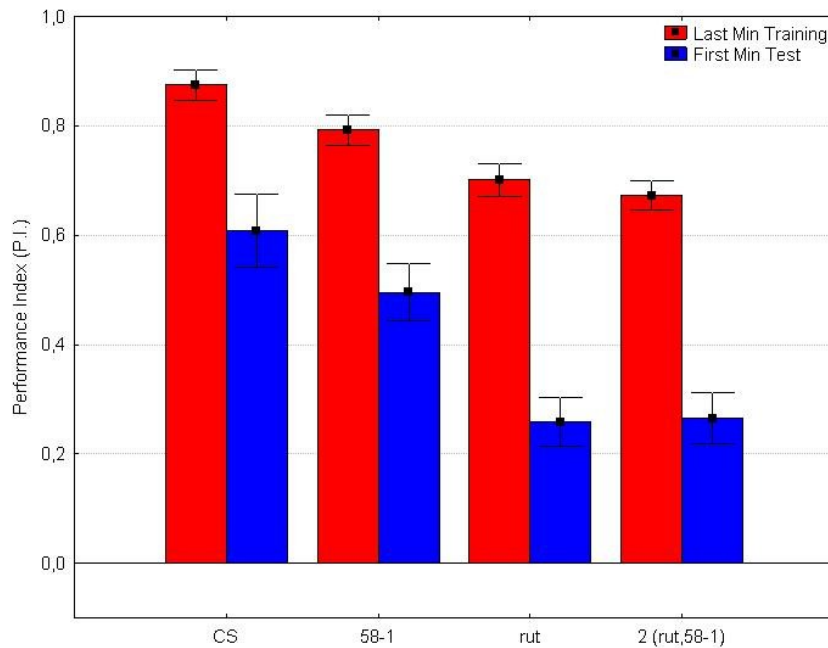

**Figure 3-17: Place conditioning of single and double mutants for *S6KII* and *rutabaga***

The null mutant of *S6KII*, *58-1* is not impaired in the standard place conditioning in the heat-box, while *rutabaga* displays the characteristic defect in both last training and first test minute ( $n \geq 60$ ,  $p < 0,001$ ). Of the double mutant lines 10, 32 and 2 only the latter was tested and its performance was statistically not distinguishable from the one of the *rut*<sup>2080</sup> mutant ( $n \geq 110$ ,  $p > 0,05$ ).

As expected, in the heat-box the double mutant *rut*<sup>2080</sup>,*58-1* shows a phenotype similar to the one characteristic of the original *rut*<sup>2080</sup> line. Together with the results obtained in the olfactory conditioning paradigm, the effect of the double mutant on place learning strengthens the hypothesis that both proteins are working on the same pathway in associative short term memory.

### 3.2.5 Effect of cold shock on place conditioning in the heat-box

Experimental flies were always segregated according to gender prior to each experiment in the heat-box. This procedure was done by naked-eye immediately before the introduction of the fly into the chamber. For a brief period, however, gender segregation was done on the day before the experiment after having anesthetized the flies by cold shock on a frozen plate for not longer than 10 minutes and separating them after observation under the microscope. This procedure was more precise in the selection but it had to be tested for side effects.

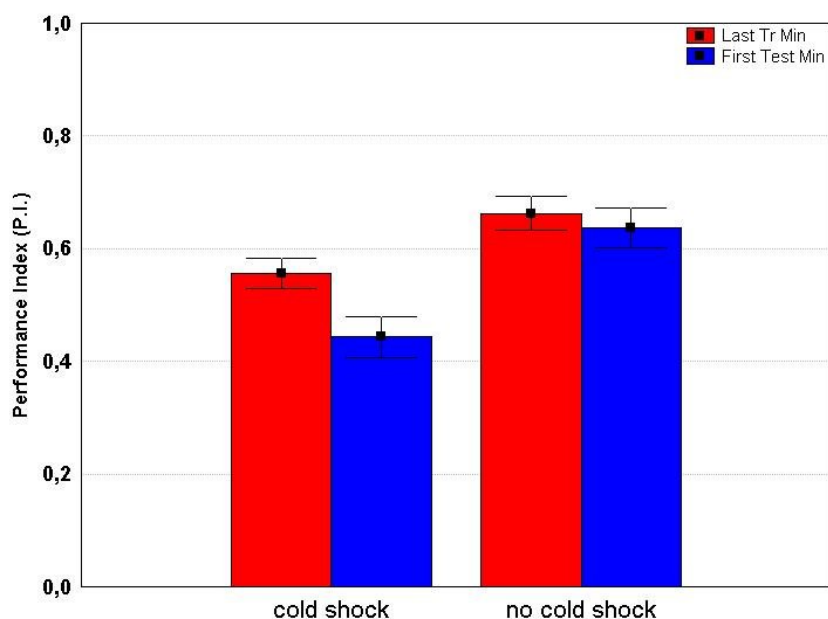

**Figure 3-18: Effects of cold shock to following heat-box conditioning**

Different technique used for gender segregation prior to place conditioning. Flies from the “cold shock” group were anesthetized at the day before experiments, while flies from the “no cold shock” group were selected by naked eye immediately before the experiment session. Flies subjected to the first treatment showed a decreased learning and memory score in compared to the no-cold-shocked flies ( $n \geq 110$ , red bars  $p < 0,01$ , blue bars  $p < 0,001$ ).

Although the technique of gender segregation of cold-anesthetized flies had the advantage of higher accuracy, it revealed itself as inappropriate, since it was more time consuming and above all caused flies to perform less well in place learning in the heat-box as not cold shocked flies. In fact flies which stayed approximately 10 minutes on the cold plate, on the next day failed to perform as well as the one which did not experience cold-shock. The reason of this decrement in performance is neural damage due to lack of oxygen. Therefore the cold shock segregation was later on abandoned.

### 3.3 The “idle” experiment, a novel assay for the heat-box

The heat-box represents a very powerful tool to study place learning. The standard procedure used in the paradigm presents not only advantages; there are some inconveniences which complicate the interpretation of data. For example, so far it is not clear how to discriminate, during the training phase, simple heat avoidance from place learning and, during the test phase, the so called “stay-where-you-are” effect from memory without underestimating the latter (Wustmann et al., 1996). Besides, in the standard experiment, hyperactivity of the flies can mimic a learning and memory defect (Putz, 2002). Moreover place learning in the heat-box seems prone to accumulating genetic modifiers, since it has been observed that the phenotype of many mutant lines would get lost if these were not permanently outcrossed to the wildtype background (Putz, 2002). Such modifications are

frequently observed in structural brain mutants where they mask the anatomical defect (Heisenberg, 1980; de Belle and Heisenberg, 1996) and might be responsible for the partial or complete loss of the behavioral phenotype.

A major uncertainty concerning this paradigm is that it is not clear whether the standard procedure measures purely operant conditioning or whether “contaminations” of classical conditioning components are present. In fact the flies might use tactile stimuli to determine their position in the chamber and associate with the negative heat-stimulus some of these positions. That would mean that the paradigm involves classical conditioning.

At present the yaw torque experiment in the flight simulator constitutes the only purely operant paradigm available in *Drosophila* neuroscience. It is basically a task where the fly is suspended at a torque meter and forced to associate its own torque movements with a heat shock free from other external stimuli which can be related to the punishment (Wolf and Heisenberg, 1991).

A new kind of learning test for the heat-box has been developed in which no classical conditioning component is involved. It is called “idle-experiment”. In the training phase “master” flies are conditioned, by heat-punishment in concomitance to stationary (idle) periods, to increase self-motion. The heat-shock is turned off as soon as the fly moves. In the test phase their activity level is measured by the total length of the rest periods. As control yoked “slave” flies are measured in parallel and receive the same amount of heat-punishment simultaneously to the respective master fly. Therefore the heat-shock for slave flies occurs randomly, following a sequence uncorrelated to their own activity. The degree by which master flies pause less than slave flies during the post training test phase is an index for a pure operant conditioning.

The rationale behind the calculation of the performance index is that slave flies after the random heat punishment during the training phase are excited and their locomotion activity increases. On the other hand master flies should further increase their activity because in their case the punishment is associated with idleness. Measuring how long the flies do not move during the final test period after the training and subtracting the slave’ from the master flies’ values will quantify the effectiveness of the operant conditioning.

In order to find the most effective experimental conditions several parameters were varied: the length of the training procedure, the duration of the “idle” status, the shock temperature and the calculation procedure.

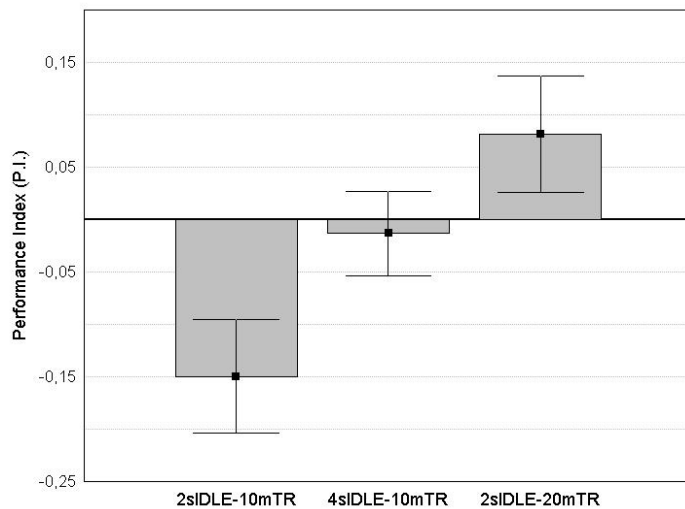

**Figure 3-19: Idle experiment, different settings**

In the idle experiment flies are divided in two groups: master and yoked slave flies. During the training period the master is punished by heat-shock if it does not move, at the same time the correspondent slave fly is punished. Therefore only master flies have the possibility to associate the punishment with their own immobility. At the end of the training a test phase starts in which the heat-shock is turned off and idle-time is measured and normalized for the length of the period. The values of the slave flies are subtracted from that of the corresponding master flies producing an evaluation of the operant conditioning which gives the performance

index. In this graph different settings for the idle experiment are shown: in the left bar master flies were punished each time they did not move for at least 2 seconds during a training period of 10 minutes. In the subsequent test period of 30 seconds master flies were less “idle”, they were moving more than slave flies for 15% of the test time (mean  $\neq 0$ ;  $p < 0,05$ ), which means that master flies were in motion on the average 4,5 seconds more than slave flies. The conditioning trial did not showed the desired response in the case that master flies were punished if they did not move for periods longer than 4 seconds (middle bar, mean not different from 0;  $p > 0,05$ ) and unexpectedly also maintaining the “idle” status threshold to 2 seconds but prolonging the training time to 20 minutes did not improved the results (right bar, mean not different from 0;  $p > 0,05$ ). Each mean  $\geq 32$  master-slave pairs.

It was found that flies were able to associate their own inactivity with a negative stimulus like a heat-shock; in this case master flies were punished every time they stopped for at least 2 seconds during a training period of 10 minutes. This setup seems to effectively condition master flies in their mean walking activity, in fact on the average they were moving in the chamber for 4,5 seconds more than slave flies during the 30 seconds final test phase. No spatial information could be associated with the punishment since this could occur through and the length of the chamber. Flies which did not move at all during the final test phase were considered injured or dead and therefore both flies of the corresponding master-slave couple were discarded. These were more than 60% of the measured flies. The large loss could have been a consequence of the enormous stress to which flies were exposed during the training; it was calculated that some flies were receiving up to 200 heat shocks during the 10 minutes training period. In order to decrease the amount of shocks, we tried to punish flies if the masters would be “idle” for at least 4 seconds instead of 2. That modification indeed decreased the number of heat shocks and consequently also the number of discarded flies, but, as shown by the middle bar in the figure 3-19, it failed to increase activity of master flies more than that of slave flies.

A further adjustment was to prolong the training time to see if it was possible to increase the performance of master flies. Therefore its duration was extended from 10 to 20 minutes. Unfortunately this caused the negative effect of an even higher number of discarded

flies and failed to produce an increased activity of master flies in respect to slave flies. That can be explained by a possible excessive heat-shocking which may harm flies and prevent any form of operant conditioning.

At the moment it seems that the best settings to condition walking activity is by heat-shocking each 2 sec pause for a training period of 10 minutes. This leads to an increased activity. Trials have been as well made to decrease walking activity in flies. This was attempted by punishing the flies each time they were moving for more than 2 seconds. The experiment failed since flies instinctively started to walk by each heat-shock in order to avoid heat and finished the training phase severely dehydrated (data not shown). The escape behavior was probably too strong to be contrasted by an induced “stay or burn” conditioning. Therefore a modification was implemented; it consisted of punishing the flies by a cold-shock instead of the standard 37°C heat-shock. Experiments by Zars and colleagues (2006) showed that flies in the heat-box can be conditioned by temperatures above and below 24°C although lower temperatures seem not to have the same efficacy as high ones. A series of experiments was designed to clarify whether it was possible to train flies to decrease their activity by punishing their walking phases (longer than 2 seconds) with 18°C cold-shocks. Surprisingly, the activity levels of masters and slaves in this case were not distinguishable from each other ( $p > 0,05$ , data not shown).

The idle experiment is a novel paradigm which still needs improvements, but already at this stage it was reputed stable enough to test known learning and memory mutants like *rut2080* and *ign*. 2 sec pauses were punished and the training lasted 10 minutes.

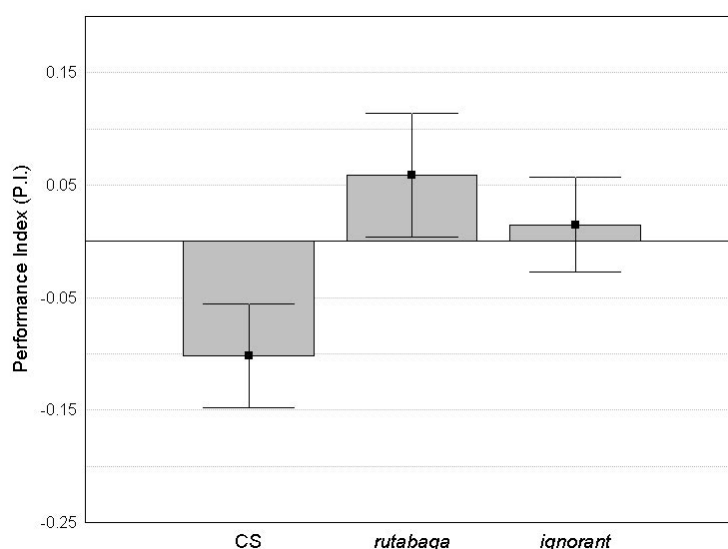

**Figure 3-20: Performance of learning and memory mutants in the idle experiment**

Only in CS flies master activity differs from slave activity (mean  $\neq 0$ ;  $p < 0,05$ ), while for *rutabaga* and *ign* the difference between master and slave activity is not statistically distinguishable from 0 ( $p > 0,05$ ), indicating that in both mutants master and slave flies present similar activity levels. Each mean indicates the performance of at least 49 master-slave pairs.

Only in wildtype flies a significant difference between master and slave activity could be detected during the test phase. Concerning the learning mutants tested in parallel it was interesting to find out that there was no difference between the activity of the respective master and slave flies. Apparently master flies were not able to form an association between their own motionlessness and the heat punishment. It is probably too soon to declare that this is caused by the respective mutations, since the means of the three different groups are too similar (ANOVA  $p > 0,05$ ), but the results obtained in this novel experiment are encouraging and pushing for the further development of a purely operant conditioning paradigm in the heat-box.

### **3.4 Learned helplessness**

Exposure to uncontrollable stress generalizes to other situations and causes deficits in learning performance. This interference effect has been named learned helplessness and has been observed in humans, dogs, cats, goldfish, mice, rats, gerbils, cockroaches and slugs (reviewed in Eisenstein and Carlson, 1997) and there is as well a single case where it has been experimentally observed in *Drosophila* (Brown et al., 1996). The most famous example of this phenomenon is related with dogs and it has been demonstrated in a number of studies: when dogs receive a sequence of inescapable shocks, they later fail to learn to escape shock in a shuttle box (Seligman and Maier, 1967). The dogs simply sit and passively receive the shock without showing efforts to escape. The animals have allegedly learned from their previous experience with the inescapable shocks that reacting is useless.

After a discussion about the “idle experiment”, Prof. David J. Anderson, from the California Institute of Technology, noticed the similarity of that experiment to the procedure used in other laboratories to induce learned helplessness on experimental model organisms. In effect during the idle experiment the conditions for master and slave flies are nearly identical, the only distinction is that in the first case flies have some degree of control over the punishment (they can stop it by moving) while for the slave flies the shock is absolutely unpredictable and inescapable.

#### **3.4.1 Learned helplessness in the heat-box**

The heat-box seemed to be the ideal paradigm to study learned helplessness since it is not necessary to remove flies after the stress induction caused during the idle experiment. By

performing a standard experiment immediately after the idle experiment it could be tested if the slave flies (in Seligman's terms the inescapable group) would reveal a learning deficit in contrast to the master flies (the escapable group).

A control group was also introduced in the experimental sessions; a group of flies which during the 10 minutes training would not be exposed to intermittent heat-shocks but rather to a slightly increased constant temperature of 27°C, equivalent to the amount of heat to which in average master and slave flies are exposed during the training phase.

In preliminary studies it was observed that it would have not been necessary to perform the standard experiment with the established protocol of 4 minutes training 3 minutes test. After 10 minutes of heat exposures in the idle experiment flies were very sensitive to higher temperatures. Flies were extremely rapid in reaching high performance indices already after one minute training. Therefore to test for learned helplessness a shorter version of the standard experiment was used, consisting of one minute training and one minute test.

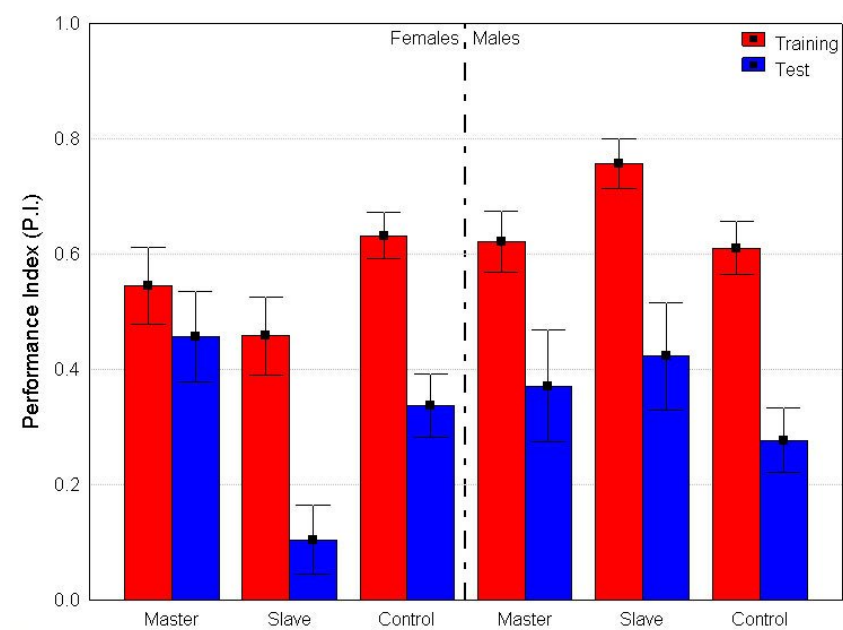

**Figure 3-21: Learned helplessness in the heat-box**

A shortened version of the standard heat-box experiment is displayed: 1 minute training followed by 1 minute test. The female slave flies, which previously experienced the inescapable heat-shock, show a deficit in respect to both master and control flies ( $p < 0,001$ ). Interestingly this effect is not detectable in males, where all three groups perform equally ( $p > 0,05$ ).

Performances of master and slave female flies in the shortened standard heat-box experiment were different. Females exposed to the inescapable heat-shocks performed less than females of the escapable group and of the control group. This result is even more significant if it is taken into account that master flies during the idle experiment which precede the standard experiment are pushed to be more active and it has been observed that higher activity is negatively correlated with performance in the standard heat-box experiment (Putz, 2002). Therefore master flies in the trial following the idle experiment are expected to



show a lower performance than slave flies, because of their higher activity, but this is not the case. In fact, slave flies display a decrement in the performance which is significant if compared to both master and control group. Female slaves show learned helplessness: they are impaired in place learning. Interestingly, males do not show this deficit. In other organisms a sexual dimorphism of the helplessness effect has already been described and correlated with sexual hormones (Jenkins et al., 2001). This is the first evidence of gender dependent learned helplessness in arthropods.

### **3.4.2 Effect of antidepressants on learned helplessness in the heat-box**

Learned helplessness is a valid animal model of stress-induced behavioral depression in which prior exposure to inescapable stress produces deficits in escape testing (Willner, 1991). The learned helplessness hypothesis offers an opportunity to understand some of the behavioral and neurochemical correlates of clinical depression. In many laboratories learned helplessness is induced in model organisms like rats or mice for testing antidepressants (reviewed in Monleon et al., 2007).

The majority of antidepressants work on serotonin metabolism because it has been observed that disruption of the synthesis, metabolism or uptake of this neurotransmitter is partially responsible for certain manifestations of schizophrenia, depression and compulsive disorders (reviewed in Turner et al., 2006).

Y. Ritze, Biozentrum Würzburg, has shown that it is possible to modify serotonin levels in flies by feeding them with antidepressants like 5H-Tryptophan (the precursor of Serotonin). A serotonin reuptake inhibitor, Parox, was not able to increase serotonin levels in fly heads (see Figure 3-22). This happened presumably because the inhibition of the reuptake process does not influence the syntheses or the disruption of serotonin, but only its storage in the vacuolar compartments or in the synaptic cleft, therefore the serotonin levels remain unaltered even after this drug treatment.

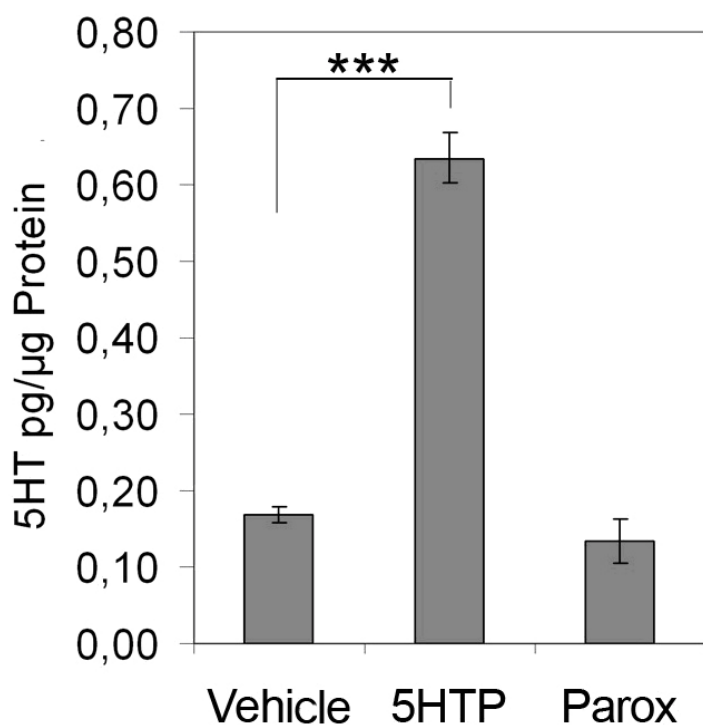

**Figure 3-22: Impact of feeding antidepressants on serotonin levels in *Drosophila***

Serotonin concentration in fly heads was measured by an ELISA. Feeding of the 5-HT precursor 5-hydroxytryptophan leads to an increase of serotonin levels. Feeding of Parox, a serotonin reuptake inhibitor, did not cause variations in serotonin concentration in fly heads (\*\*\*) =  $p < 0,001$ , modified figure from Y. Ritze).

Since in the previously experiments a new paradigm of learned helplessness phenomenon was established in *Drosophila* and because it was proven that feeding flies with antidepressants could affect serotonin levels (Figure 3-22) and modulate the organism behavior (Yuan et al., 2005), it was tried to revert learned helplessness by means of antidepressants. The substances chosen were 5-Hydroxytryptophan, the precursor of 5-HT and two different serotonin reuptake inhibitors: Fluoxetine (component of Prozac, the world most common antidepressant) and Citalopram.

Flies were left overnight on middle-sized vials with two paper stripes soaked in a 5% sugar solution for the control group, the experimental groups were stored in the same way. The only difference was that either 5-HTP (2mg/ml), Fluoxetine (1mg/ml) or Citalopram (1mg/ml) was added to the sugar solution.

On the next day, following a random sequence, flies of each group were first exposed in the heat-box to either escapable or inescapable shocks and subsequently tested with the shortened standard procedure.

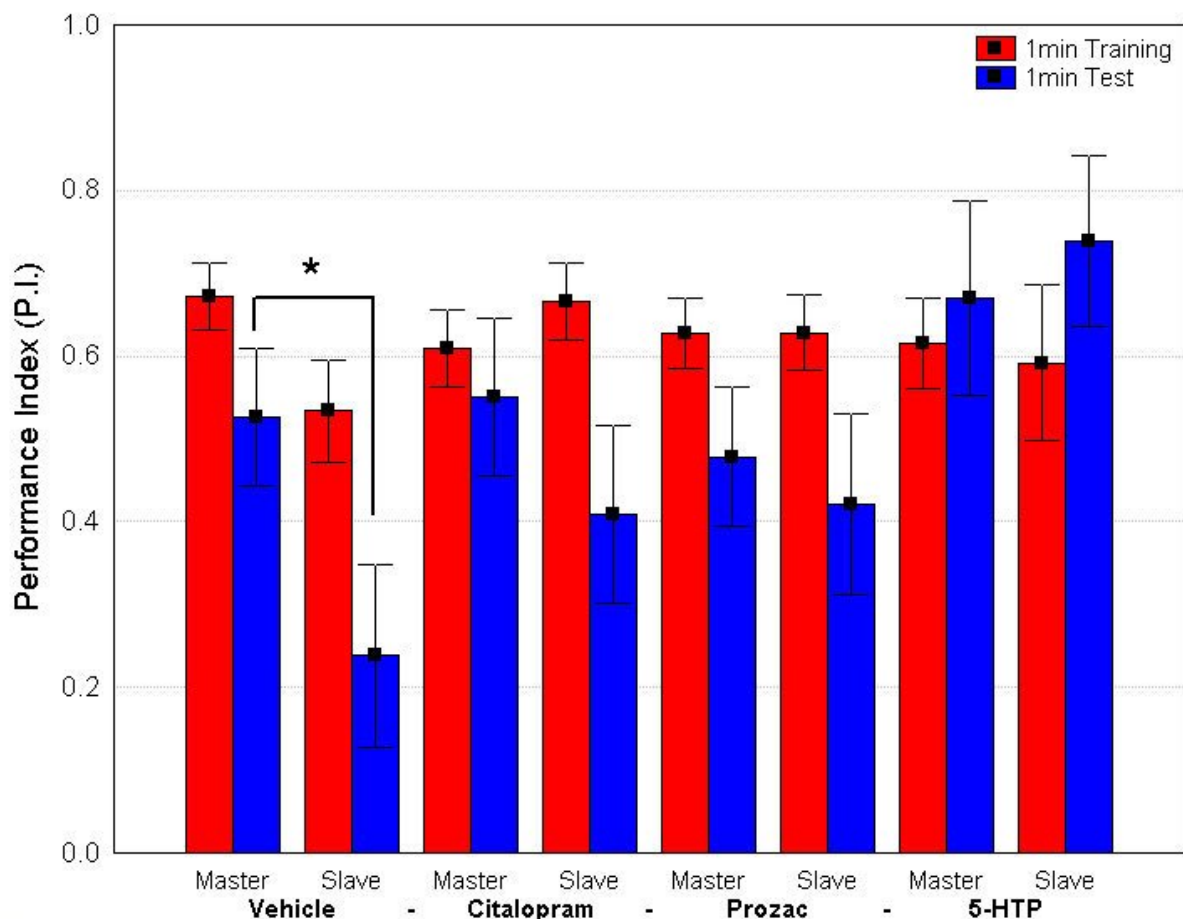

**Figure 3-23: Effect of antidepressant treatment on learned helplessness in *Drosophila***

Pharmacological serotonergic agents reduce the learned helplessness effect induced by prolonged exposure to inescapable shocks showed by the slave flies group. Compared to vehicle treated flies, flies treated with the serotonin reuptake inhibitors either Citalopram or Prozac (fluoxetine hydrochloride) did not show the learned helplessness effect. Also in the group of flies fed with the serotonin precursor 5-HTP performance of master and slave groups were indistinguishable ( $p > 0,05$ ). Only females are shown.

Slave flies exposed to inescapable shocks performed poorly in the standard heat-box task carried out immediately after the shock session, exhibiting a significant decrease in place learning compared to the group of the escapable shock flies. This effect was observable only in females. Learned helplessness in flies can be reversed by treatment with all three antidepressants drugs, Citalopram, Prozac and 5-HTP. In all cases the antidepressant drugs had an enhancing effect on the performance in the retention period of the place conditioning task. The data of the present study show that the SSRIs reduce the escape deficits produced by inescapable shocks in flies, in accordance with data previously reported in rats for this class of antidepressants (Takamori et al., 2001).

It has not escaped my notice that both master and slave flies treated with 5-HTP tended to perform better than flies fed with only sugar solution, suggesting that the unnaturally elevated serotonin level showed in figure 3-22 could provide a more efficient stress resistance throughout the whole experimental procedure.

This experiment represents the first example of a potential contribution of *Drosophila* as an animal model in tests for antidepressants, which would not only examine the toxicity but also the efficacy of the drugs. The optimization of the setup of the paradigm is still in a preliminary phase but the results are promising and the possible future applications of this kind of experiment strongly suggest its further improvement.

## 4 Discussion

### 4.1 Characterization of memories in *S6KII* mutants

For many years a successful approach to identifying genes participating in learning and memory formation has been the characterization of *Drosophila* mutants which showed defects in the most disparate behavioral tasks like the flight simulator or the courtship conditioning paradigm (Davis, 1996; Davis, 2005).

#### 4.1.1 Olfactory conditioning

Focusing the attention on olfactory learning and memory, it can be acknowledged that the most deeply characterized class of learning mutants are involved in cAMP-dependent signaling. The corresponding genes include *dunce*, which encodes a cAMP-dependent phosphodiesterase (Dudai et al., 1976; Byers et al., 1981); *rutabaga*, encoding an adenylyl cyclase (Livingstone et al., 1984; Tully and Quinn, 1985); *DCO*, encoding a cAMP-dependent protein kinase (PKA, Yin et al., 1994). The results of behavioral studies on these mutants corroborate the idea that the cAMP cascade might play a central role in learning. However, it is speculated that several alternative regulative mechanisms are involved in memory formation. This hypothesis is sustained by the discovery of additional classes of *Drosophila* learning mutants which may encode proteins relevant in this process (Davis, 1996). One of these mutants identifies the gene *leonardo*, that encodes a conserved member of the 14-3-3 protein family. *Leonardo* mutants show decreased learning performance correlated with the level of expressed protein; the most impaired mutants show a 30% decrement in associative learning (Skoulakis and Davis, 1996). Null *leonardo* mutants die as mature embryos indicating that the protein also plays an essential function for survival. The central nervous system shows abundance of *leonardo* protein, especially in the mushroom body. This specific localization strengthens the hypothesis that *leonardo* plays an essential role in associative learning. Remarkably, *leonardo*, differently from the most learning and memory mutants, is not known to participate in the cAMP cascade. Therefore, an additional cascade, the mitogen activated protein kinase (MAPK) signal transduction cascade has to be considered to play a role in learning and memory (Skoulakis and Davis, 1996). Another mutant which presents

defective learning and memory and so far has not been associated with the cAMP cascade family is *ignorantP1* (Putz et al., 2004). *Ignorant* null mutants are viable and in olfactory conditioning they reach only 50-60% of the wildtype performance although their sensitivity to the CS and US alone remains unaltered (Bertolucci, 2002). As previously cited, *S6KII* does not belong to the cAMP cascade rather, like *leonardo*, to the mitogen activated protein kinase (MAPK) signaling cascade.

The *S6KII* null mutants which displayed a defective memory score in previous experiments were generated by imprecise jumpout of a P-element located on the first exon of the gene. From the same original line which generated the null deletion mutant two other precise jumpout lines were generated. One of these was chosen as a positive control for behavioral characterization. This line which could avail the completely restored sequence of the gene displayed a normal score in olfactory learning (Bertolucci, 2002). This finding represented substantial evidence that the disruption of the gene was responsible for the observed phenotype in the olfactory conditioning experiment. On the other hand it could not exclude the possibility that the phenotype could have been the consequence of the disturbance of the expression of a neighboring gene. This hypothesis needed further investigation since it was later discovered that the *S6KII* gene was located in an intron of another gene (*CG17600*), whose molecular function is yet to be discovered. Therefore it was planned to perform a genomic rescue crossing the null mutant with a transgenic line which contained a pW8 vector with an extra copy of the *S6KII* gene inserted on a specific autosome. The site of plasmid insertion was previously characterized in order to avoid X-chromosomal insertion lines through the crossing scheme. The genomic rescue gave positive results: 58-1/Y;T1/+ males learned significantly better than 58-1/Y, which did not have the transgene insertion, and were indistinguishable from the wildtype control. This result proved that *S6KII* is responsible for the learning and memory defect because the genomic transgene does not contain *CG17600* and is inserted far away from the original genomic location.

The phenotype displayed by the partial deletion line 24-3 showed that also the disruption of the expression of the N-terminal region is sufficient to display the behavioral defect characteristic of the null mutant (Bertolucci, 2002), suggesting that the elimination of its phosphorylating unit disrupts its effect on the substrate in an analogous way as the complete deletion of the genomic sequence and indicating the N-terminal region as the key domain for the effective phosphorylation of the kinase's targets. Similarly to the memory

defect in the null mutant also the partial deletion induced effect could be reverted by transgenic *S6KII* expression.

In previous studies of operant place conditioning in the heat-box both homozygous and heterozygous females of the partial deletion displayed a defective performance score in (Putz et al., 2004). In classical odor conditioning the outcome is different, augmenting the behavioral divergences of the imprecise excision line 24-3 in the two associative paradigms. In the Tully machine both the complete and the partial deletion only show a phenotype in a homozygous state, while the presence of a single intact copy of the gene in the heterozygous females is sufficient to provide a normal performance. Furthermore this result indicates that the presence of the truncated protein in the line 24-3 does not interfere with normal performance in classical odorant conditioning.

The transgenic lines used in the genomic rescue did not show any deleterious effect in olfactory conditioning. On the contrary, at first sight it seemed that overexpression even produced a better score than wildtype (see Figure 3-2) in a way analogous to how mutants overexpressing *DaPKM* perform in olfactory conditioning (Drier et al., 2002). Nevertheless, further measurements ruled out this hypothesis, since the performance of both transgenic lines *T1* and *T4-2* turned out indistinguishable from wildtype.

A temporally controlled expression of the *S6KII* gene, driven by heat shock inducible *GAL4* in the null mutant, allowed determining that the kinase is required for olfactory learning during the adult stage, ruling out a hypothetical learning and memory defect dependent on a developmental requirement of *S6KII*.

The next goal was to localize the brain structure where *S6KII* is needed to allow for olfactory learning and memory by mapping localized necessary gene expression in transgenic animals using the *GAL4-UAS* system in a way which was already used with the gene *rutabaga* (Zars et al., 2000).

If olfactory learning is impaired in *S6KII* null mutants because the kinase is missing in a defined set of neurons it should suffice to restore the kinase in just these cells to rescue the learning performance. If the kinase is part of the memory trace for the respective odor, the corresponding memory trace is mapped to the set of neurons expressing the kinase. First trials were performed using a pan-neuronal driver like *elav-GAL4* which would express the yeast

transcription factor in all neurons (Yao et al., 1993; Ito et al., 1998). This pan-neuronal expression of *S6KII* fully restored olfactory learning in the *58-1* null mutant.

Subsequently a series of GAL4 enhancer trap lines were selected for local rescue because of their expression patterns, mostly localized in the mushroom bodies, which are overall identified as main site for olfactory learning (de Belle and Heisenberg, 1994). It has been already shown that genes which play an important role in olfactory learning and memory like *rutabaga* have pronounced expression levels in the mushroom bodies (Tully and Quinn, 1985; Han et al., 1992). As expected no significant difference could be observed between *S6KII* null mutant flies PIs rescued with a mushroom body specific enhancer trap line (*mb247GAL4*) compared to wildtype flies.

Other GAL4 lines were used to rescue *S6KII*. These were previously used to study olfactory learning after either expressing a constitutively active G-protein  $\alpha$  subunit (*Gas\**) (Connolly et al., 1996) or restoring *rutabaga* expression in a *rutabaga* mutant (Zars et al., 2000). These lines were *c772*, *30y* and *c232* and in the present experiment the efficacy of the rescue was similar to the suppressive effect of the *Gas\** protein (Connolly et al., 1996) and to the *rutabaga* rescues experiments of Zars and colleagues (2000). Both *c772* and *30y* could rescue olfactory learning in the null mutant *58-1* showing a performance indistinguishable from wildtype, while in *c232* the rescue effect was totally absent. By examining the expression patterns of the rescue and non-rescue *GAL4* lines it was possible to determine which brain structures are sufficient for olfactory short-term memory. These structures are confirmed to be specifically the mushroom bodies, while other structures like the median bundle, the antennal lobes and the ellipsoid body are not part of the set of the minimally sufficient structures where *S6KII* expression is needed.

*Rutabaga*, which encodes a calmodulin dependent adenylate cyclase that converts ATP to cyclic AMP, is known to play a critical role in *Drosophila* olfactory learning. Neural stimulation results in calcium ions flowing into the cell, leading to activation of adenyl cyclase and a rise in cAMP levels. cAMP, one of the central chemical messengers of the cell, then activates protein kinase A (Davis, 1996), which has been recently identified as a phosphorylating factor of MAPK which then initiates a phosphorylation cascade. This comprises *S6KII* and leads to the induction of genes important for long term memory (Waltereit and Weller, 2003). This pathway is a major alternative to the signaling cascades from  $\text{Ca}^{2+}$  to MAPK via Ras (see Figure 1-4) and suggests that *rutabaga* and *S6KII* are active on the same signaling way. The experiments performed with *rutabaga-S6KII* double mutants



confirmed this hypothesis; in fact, not only the single mutation phenotypes present a nearly identical grade, but remarkably all three lines which contained both mutations showed a non additive effect of the single mutation defects, like the same signaling cascade would be interrupted on two different spots. This could be conceivable only if both rutabaga and S6KII would operate on the same biochemical pathway.

In the attempt to better understand which structures were depending on S6KII to assure normal olfactory learning a novel technique was applied. Besides the avail of null mutants another way to analyze loss-of-function phenotypes is through targeted expression of RNA-mediated interference (RNAi). The GAL4/UAS system is often associated with the analysis of gain-of-function phenotypes. However, its recent combination with RNAi technology is rising as an effective tool for analysis of loss-of-function phenotypes as well. At this time, a variety of approaches have been adopted and proven successful for the directed expression of constructs that form double-stranded RNA (dsRNA) molecules (Duffy, 2002). This kind of approach was tried also for S6KII, both a strong pan-neuronal (*nSyB*) and a MB specific (*mb247*) GAL4 driver line were combined with an UAS vector line containing dsS6KII RNA in order to induce RNA interference in specific tissues. This approach did not produce the expected results since it failed to generate a detectable learning and memory impairment. The reasons may be found in a hypothetical insufficient amount of dsRNA expressed in the targeted cells which led to a residual amount of S6KII, sufficient for normal olfactory learning. Another reason may be found in the fact that RNAi presents a still not explained limitation in neurons, maybe because of a sort of self-defense mechanism against dsRNA, which typically leads to low efficacy in those cells (personal communication, citation needed).

#### 4.1.2 Place conditioning

Regarding place conditioning of *S6KII* mutants the situation is more complex than with olfactory conditioning, as the *58-1* null mutants in contrast to the *24-3* partial deletion mutant did not show a phenotype in the heat-box experiments and the original *8522* P-element insertion line showed a sexual dimorphism for the defective performance (Putz et al., 2004). The situation became even more complicated analyzing the deficient performance of transgenic mutant lines. Comparing the behavioral data to the S6KII levels detected on the Western blot, it can be noticed that the severity of the performance defect is correlated with protein dosage. This hypothesis can be further confirmed by observing that in heterozygous

transgene flies carrying a single copy of the transgene (T1/+), the phenotype emerged with a minor intensity in respect to the homozygous mutant (T1/T1).

*T1* was crossed to various *S6KII* mutants. *58-1/Y; T1/+* males carrying a single dose of *S6KII* as a transgene showed normal training performance. This indicates that loss of the endogenous *S6KII* gene can compensate for the dominant-negative effect of the transgene, suggesting that the latter is imputable to dosage rather than tissue specificity (i.e., a modified expression pattern of the transgene). The defect shown by the transgenic lines in place conditioning is not attributable to higher activity levels, since in the prolonged experiment it was evident that the period of rest contributed in some cases to an improvement of performance, while the gap between CS and the transgenic lines remained unaltered.

It was not possible to determine in which morphological structures overexpression of *S6KII* was disrupting place learning and memory since disappointingly the UAS effector lines were performing as badly as the experimental flies. Moreover, in general, the investigation of the place conditioning phenotype of *S6KII* mutants was made more complicated because the results went eventually more difficult if not impossible to reproduce. This might be caused by an accumulation of modifiers (suppressors) through generations (Tully and Quinn, 1985).

Both the cAMP and MAPK signaling pathways play critical roles in synaptic plasticity (Davis and Laroche, 2006). Even though many molecular interactions between these pathways have been identified, little is known about which are the molecular components of such interactions and how are signals transmitted through these pathways. The behavioral analysis of *S6KII* mutants in olfactory and place learning paradigms confirms that both forms of associative conditioning require cAMP signaling (Davis, 1996; Wustmann et al., 1996) but have their cAMP-dependent memory traces in different set of neurons (Zars et al., 2000; Zars et al., 2000). Recent studies put *S6KII* downstream of cAMP in the same signaling pathway (Impey et al., 1999) and the results in olfactory conditioning seem to confirm this fact also in *Drosophila*, while in the case of place conditioning the fact that *S6KII* is dispensable suggests that it may rather be involved in a secondary branch of the pathway. From another point of view, the phenotypes of the overexpressing transgenic lines suggest that an interaction partner or a homologue of *S6KII* should be directly involved in place learning. For instance, the signaling pathways for the two learning tasks might diverge at the level of the MAPK that could be blocked by an excess of *S6KII* and, hypothetically, by the small peptide expressed by the truncated sequence in the line 24-3.

## 4.2 The “Idle experiment”

A novel experiment, called “idle experiment” might represent a valid alternative to the “standard” heat-box experiment and also seems to overcome a series of factors like bias generated from hyperactivity of the flies, ambiguity between place learning and “stay-where-you-are” effect or contaminations of classical conditioning components, all typical limitations of the “standard” place learning assay.

In the “idle experiment” activity levels of different groups of flies are taken into account and normalized in the performance calculation. Flies are punished if they stop. There is no external cue which can be associated with the unconditioned stimulus.

On the other hand the experiment is relatively new and still in a preliminary phase. This comports some disadvantages like the high number of killed (and therefore discarded) flies, probably due to excessive exposure to the heat-shock during the training and the still low performance indexes, but further development should be sufficient to overcome these weakness.

Remarkably a longer training period (20 min) did not lead to better results, on the contrary it was impossible to detect an activity difference between master and slave flies. That may be caused by too much heat-shocking. This hypothesis is confirmed by the increasing number of dead flies observed after the prolonged (20min) training. Nevertheless interestingly while wildtype flies could build a stable positive score both learning mutants, *rutabaga* and *ignorant*, did not show a performance index different from 0, providing credit to the hypothesis that the paradigm is an appropriate tool for detecting operant learning in flies.

## 4.3 Learned helplessness

The “idle experiment” turned out even more interesting and valuable as it became clear that it was perfectly suited to study learned helplessness in flies. The single citation about this phenomenon in *Drosophila* does not convince because of similarities and ambiguities in the experimental methods. In Brown et al 1996, the both phases of induction and detection of LH seem to occur during almost identical experimental procedures. We exposed flies to the negative stimuli following two subsequent experiments which were conceptually absolutely diverse; flies exposed to inescapable stress (slave group) generalized the experience and showed deficits in performance in the subsequent standard experiment, below the index of the escapable and the control group. Astonishing was the discovery that like in more complex organisms like mice and rats (Conrad et al., 2004; Clinton et al., 2007), flies showed a sexual

dimorphism in learned helplessness. Basically the complexity of the nervous systems of the species being often examined in LH studies makes research in this area extremely difficult and a transferring the approach to a relatively simpler model organism conveys a lot of productive advantages (Thompson, 1986). An invertebrate model of the LH effect should also benefit the development and the understanding of the neurological mechanisms which are involved in this phenomenon. The abundance of genetic tools and the relatively simple nervous system make of *Drosophila* a perfect candidate to examine LH. In more complex organisms the sexual dimorphism of LH is not always univocal, present divergences depending on the kind of stress (Dalla et al., 2007). Male rats seem more resistant to acute forms of stress (Conrad et al., 1996; Park et al., 2001), while females are better in tolerating chronic stress (Bowman et al., 2001; Bowman et al., 2003; Conrad et al., 2004). In mammals the sexual dimorphism in LH has been correlated with sexual hormones (Jenkins et al., 2001) and it can be speculated that it may be similar in flies although at the moment there is no evidence supporting this hypothesis.

LH, which is a generally accepted experimental model for depression (reviewed in Shors, 2004), has been often correlated to serotonin levels in the brain. In fact the majority of the antidepressant drugs are based on the metabolism of serotonin i.e. its precursors (5-HTP) or reuptake-inhibitors (SSRIs) (reviewed in Asberg et al., 1986). Three kinds of this category of drug (Citalopram, Prozac and 5-HTP) successfully reverted LH. Apparently the treated inescapable groups were able to perform as well as the escapable group. The link between serotonin and learned helplessness in *Drosophila* is strengthened by the ELISA analysis. It shows that feeding the flies with the 5-HTP leads to an increase of serotonin levels in the head, which may lead to protection from LH.

Interestingly flies treated with 5-HTP tended to perform better than flies fed with only sugar solution, suggesting that increased serotonin level consisted in a sort of advantage common to both master and slave flies.

The perspective that flies could be used to test not only the toxicity of some drugs but also the efficacy of antidepressants opens new horizons to clinical test research in pharmacology. The economical advantages would be enormous and also in terms of flexibility there would be benefits, because with *Drosophila* one could have access to numerous genetic tools which are characteristic of this laboratory model organism. Therefore it would be of great interest to further develop both the “idle experiment” and its effects on learned helplessness in flies.

## 5 List of abbreviations

3-OCT: 3-octanol

AC: adenylyl cyclase

AL: antennal lobe

ARM: amnesia resistant memory

ATP: adenosin triphosphate

BAL: benzaldehyde

cAMP: cyclic adenosin monophosphate

CREB: cAMP response element binding protein

CS: wildtype Canton S

CS+: conditioned stimulus (paired with US)

CS–: conditioned stimulus (not paired with US)

GAL4: yeast transcription factor

G $\alpha$ s: G-protein  $\alpha$  subunit

hs: heat shock

IAA: isoamyl acetate.

LTM: long term memory

MB: mushroom body

MTM: middle term memory

n-Syb: neuronal Synaptobrevin

PI: performance index

PKA: protein kinase A

p90RSK: p90 ribosomal S6 kinase

T: temperature

UAS: upstream activation sequence

S6KII: ribosomal S6 kinase II

STM: short term memory

US: unconditioned stimulus

WT: wild type flies

## 6 Table of figures

Figure 1-1: General scheme of associative facilitation	8
Figure 1-2: Functional domains and phosphorylation sites of RSK.	12
Figure 1-3 : Activation (A) and Inactivation (B) of RSK	13
Figure 1-4: The MAPK/ERK pathway.	15
Figure 1-5: Memory phases	18
Figure 1-6: Current model of molecular pathways involved in memory formation.	19
Figure 1-7: The UAS/GAL4 system in <i>Drosophila</i> .	22
Figure 2-1: Molecular map of the <i>S6KII</i> gene (partitions, 0.5 kb)	29
Figure 2-2: T-maze olfactory learning device	32
Figure 2-3: Heat-box	36
Figure 2-4: The standard learning paradigm	37
Figure 2-5: Idle experiment	37
Figure 2-6: Thermosensitivity test	38
Figure 3-1: Western blots of WT-CS and mutants	42
Figure 3-2 : Genomic rescue in the Tully machine	43
Figure 3-3: Heterozygous <i>58-1</i> and <i>24-3</i> in olfactory learning	44
Figure 3-4: Transgenic lines in classical conditioning	45
Figure 3-5: Temporal rescue of the olfactory conditioning phenotype	46
Figure 3-6: Spatial rescue using <i>elav-GAL4</i> driver	47
Figure 3-7: Mushroom body rescue of <i>S6KII</i> in classical conditioning	48
Figure 3-8: Spatial expression of <i>GAL4</i> lines used for rescue experiments	49
Figure 3-9: Olfactory learning of <i>S6KII</i> mutant is rescued by local transgenic expression of wildtype gene	49
Figure 3-10: Olfactory conditioning of single and double mutants for <i>S6KII</i> and <i>rutabaga</i>	51
Figure 3-11: RNAi mediated silencing of <i>S6KII</i> expression in olfactory conditioning	52
Figure 3-12: Odor-intensity learning in <i>S6KII</i> and <i>rutabaga</i> mutants	53
Figure 3-13: Place learning of transgenic mutants	54
Figure 3-14: Prolonged pretest effect on wildtype and transgenic lines performance	55
Figure 3-15: Transgenic line phenotype rescued in the heat-box	56
Figure 3-16: Heat-box performance of <i>elav</i> driven overexpression in <i>S6KII</i> mutants	57
Figure 3-17: Place conditioning of single and double mutants for <i>S6KII</i> and <i>rutabaga</i>	58
Figure 3-18: Effects of cold shock to following heat-box conditioning	59
Figure 3-19: Idle experiment, different settings	61
Figure 3-20: Performance of learning and memory mutants in the idle experiment	62
Figure 3-21: Learned helplessness in the heat-box	64
Figure 3-22: Impact of feeding antidepressants on serotonin levels in <i>Drosophila</i>	66
Figure 3-23: Effect of antidepressant treatment on learned helplessness in <i>Drosophila</i>	67

## 7 Summary

One of the major challenges in neuroscience is to understand the neuronal processes that underlie learning and memory. For example, what biochemical pathways underlie the coincidence detection between stimuli during classical conditioning, or between an action and its consequences during operant conditioning? In which neural substructures is this information stored? How similar are the pathways mediating these two types of associative learning and at which level do they diverge?

The fly *Drosophila melanogaster* is an appropriate model organism to address these questions due to the availability of suitable learning paradigms and neurogenetic tools. It permits an extensive study of the functional role of the gene *S6KII* which in *Drosophila* had been found to be differentially involved in classical and operant conditioning (Bertolucci, 2002; Putz et al., 2004). Genomic rescue experiments showed that olfactory conditioning in the Tully machine, a paradigm for Pavlovian olfactory conditioning, depends on the presence of an intact *S6KII* gene. This rescue was successfully performed on both the null mutant and a partial deletion, suggesting that the removal of the phosphorylating unit of the kinase was the main cause of the functional defect.

The GAL4/UAS system was used to achieve temporal and spatial control of *S6KII* expression. It was shown that expression of the kinase during the adult stage was essential for the rescue. This finding ruled out a developmental origin of the mutant learning phenotype. Furthermore, targeted spatial rescue of *S6KII* revealed a requirement in the mushroom bodies and excluded other brain structures like the median bundle, the antennal lobes and the central complex. This pattern is very similar to the one previously identified with the *rutabaga* mutant (Zars et al., 2000). Experiments with the double mutant *rut, ign<sup>58-1</sup>* suggest that both *rutabaga* and *S6KII* operate in the same signalling pathway.

Previous studies had already shown that deviating results from operant and classical conditioning point to different roles for *S6KII* in the two types of learning (Bertolucci, 2002; Putz, 2002). This conclusion was further strengthened by the defective performance of the transgenic lines in place learning and their normal behavior in olfactory conditioning.

A novel type of learning experiment, called “idle experiment”, was designed. It is based on the conditioning of the walking activity and represents a purely operant task, overcoming some of the limitations of the “standard” heat-box experiment, a place learning paradigm. The

novel nature of the idle experiment allowed exploring “learned helplessness” in flies, unveiling astonishing similarities to more complex organisms such as rats, mice and humans. Learned helplessness in *Drosophila* is found only in females and is sensitive to antidepressants.



## Zusammenfassung

Eine der größten Herausforderungen in der Neurobiologie ist es, die neuronalen Prozesse zu verstehen, die Lernen und Gedächtnis zugrundeliegen. Welche biochemischen Pfade liegen z.B. der Koinzidenzdetektion von Reizen (klassische Konditionierung) oder einer Handlung und ihren Konsequenzen (operante Konditionierung) zugrunde? In welchen neuronalen Unterstrukturen werden diese Informationen gespeichert? Wie ähnlich sind die Stoffwechselwege, die diese beiden Arten des assoziativen Lernens vermitteln und auf welchem Niveau divergieren sie?

*Drosophila melanogaster* ist wegen der Verfügbarkeit von Lern-Paradigmen und neurogenetischen Werkzeugen ein geeigneter Modell-Organismus, um diese Fragen zu adressieren. Er ermöglicht eine umfangreiche Studie der Funktion des Gens *S6KII*, das in der Taufliege in klassischer und operanter Konditionierung unterschiedlich involviert ist (Bertolucci, 2002; Putz et al., 2004). Rettungsexperimenten zeigen, dass die olfaktorische Konditionierung in der Tully Maschine (ein klassisches, Pawlow'sches Konditionierungsparadigma) von dem Vorhandensein eines intakten *S6KII* Gens abhängt. Die Rettung war sowohl mit einer vollständigen, als auch einer partiellen Deletion erfolgreich und dies zeigt, dass der Verlust der phosphorylierenden Untereinheit der Kinase die Hauptursache des Funktionsdefektes war.

Das GAL4/UAS System wurde benutzt, um die *S6KII* Expression zeitlich und räumlich zu steuern. Es wurde gezeigt, dass die Expression der Kinase während des adulten Stadiums für die Rettung hinreichend war. Dieser Befund schließt eine Entwicklungsstörung als Ursache für den mutanten Phänotyp aus. Außerdem zeigte die gezielte räumliche Rettung von *S6KII* die Notwendigkeit der Pilzkörper und schloss Strukturen wie das mediane Bündel, die Antennalloben und den Zentralkomplex aus. Dieses Muster ist dem vorher mit der *rutabaga* Mutation identifizierten sehr ähnlich (Zars et al., 2000). Experimente mit der Doppelmutante *rut, ign<sup>58-1</sup>* deuten an, dass *rutabaga* und *S6KII* im gleichen Signalweg aktiv sind.

Vorhergehende Studien hatten bereits gezeigt, dass die unterschiedlichen Ergebnisse bei operanter und klassischer Konditionierung auf verschiedenen Rollen für *S6KII* in den zwei Arten des Lernens hindeuten (Bertolucci, 2002; Putz, 2002). Diese Schlussfolgerung wurde durch den mutanten Phänotyp der transgenen Linien in der Positionskonditionierung und ihr wildtypisches Verhalten in der klassischen Konditionierung zusätzlich bekräftigt.

Eine neue Art von Lern-Experiment, genannt „Idle Experiment“, wurde entworfen. Es basiert auf der Konditionierung der Laufaktivität, stellt eine operante Aufgabenstellung dar und überwindet einige der Limitationen des „Standard“ Heat-Box Experimentes. Die neue Art des Idle Experimentes erlaubt es, „gelernte Hilflosigkeit“ in Fliegen zu erforschen, dabei zeigte sich eine erstaunliche Ähnlichkeit zu den Vorgängen in komplizierteren Organismen wie Ratten, Mäusen oder Menschen. Gelernte Hilflosigkeit in der Tauflye wurde nur in den Weibchen beobachtet und wird von Antidepressiva beeinflusst.

## 8 References

- Abney M, McPeck MS, Ober C. 2001. Broad and narrow heritabilities of quantitative traits in a founder population. *Am J Hum Genet* 68:1302-1307.
- Abramson CI, Feinman RD. 1987. Operant punishment of eye elevation in the green crab, *Carcinus maenas*. *Behav Neural Biol* 48:259-277.
- Adams JP, Sweatt JD. 2002. Molecular psychology: roles for the ERK MAP kinase cascade in memory. *Annu Rev Pharmacol Toxicol* 42:135-163.
- Alcorta DA, Crews CM, Sweet LJ, Bankston L, Jones SW, Erikson RL. 1989. Sequence and expression of chicken and mouse rsk: homologs of *Xenopus laevis* ribosomal S6 kinase. *Mol Cell Biol* 9:3850-3859.
- Altschul SF, Gish W, Miller W, Myers EW, Lipman DJ. 1990. Basic local alignment search tool. *J Mol Biol* 215:403-410.
- Angenstein F, Greenough WT, Weiler IJ. 1998. Metabotropic glutamate receptor-initiated translocation of protein kinase p90rsk to polyribosomes: a possible factor regulating synaptic protein synthesis. *Proc Natl Acad Sci U S A* 95:15078-15083.
- Asberg M, Eriksson B, Martensson B, Traskman-Bendz L, Wagner A. 1986. Therapeutic effects of serotonin uptake inhibitors in depression. *J Clin Psychiatry* 47 Suppl:23-35.
- Ausubel FM, Brent DDK, J. G. Seidman, J. A. Smith, Struhl. K. 1994 *Current Protocols in Molecular Biology*. .
- Balschun D, Wolfer DP, Gass P, Mantamadiotis T, Welzl H, Schutz G, Frey JU, Lipp HP. 2003. Does cAMP response element-binding protein have a pivotal role in hippocampal synaptic plasticity and hippocampus-dependent memory? *J Neurosci* 23:6304-6314.

- 
- Berger RJ. 1968. Operant conditioning of eye movement in the monkey (*Macaca nemestrina*).  
*J Exp Anal Behav* 11:311-320.
- Bertolucci F. 2002. Characterization of learning and memory in *Drosophila* S6KII (ignorant) mutants in classical conditioning  
In: Würzburg: Bayerische Julius-Maximilians-Universität Würzburg.
- Booker R, Quinn WG. 1981. Conditioning of leg position in normal and mutant *Drosophila*.  
*Proc Natl Acad Sci U S A* 78:3940-3944.
- Bowman RE, Beck KD, Luine VN. 2003. Chronic stress effects on memory: sex differences in performance and monoaminergic activity. *Horm Behav* 43:48-59.
- Bowman RE, Zrull MC, Luine VN. 2001. Chronic restraint stress enhances radial arm maze performance in female rats. *Brain Res* 904:279-289.
- Boynton S, Tully T. 1992. *latheo*, a new gene involved in associative learning and memory in *Drosophila melanogaster*, identified from P element mutagenesis. *Genetics* 131:655-672.
- Brand AH, Perrimon N. 1993. Targeted gene expression as a means of altering cell fates and generating dominant phenotypes. *Development* 118:401-415.
- Brembs B. 2003. Operant conditioning in invertebrates. *Curr Opin Neurobiol* 13:710-717.
- Brembs B, Heisenberg M. 2000. The operant and the classical in conditioned orientation of *Drosophila melanogaster* at the flight simulator. *Learn Mem* 7:104-115.
- Brembs B, Lorenzetti FD, Reyes FD, Baxter DA, Byrne JH. 2002. Operant reward learning in *Aplysia*: neuronal correlates and mechanisms. *Science* 296:1706-1709.
- Bretschneider F. 1914. Über die Gehirne der Kuchenschabe und des Mehlkäfers. *Jena Z. Naturwiss.* 52:269-362.
- Brown GE, Davenport DA, Howe AR. 1994. Escape deficits induced by a biologically relevant stressor in the slug (*Limax maximus*). *Psychol Rep* 75:1187-1192.

- 
- Brown GE, Mitchell AL, Percy AM, Robertson CL. 1996. Learned helplessness in *Drosophila melanogaster*? *Psychol Rep* 78:962.
- Brown GE, Stroup K. 1988. Learned helplessness in the cockroach (*Periplaneta americana*). *Behav Neural Biol* 50:246-250.
- Byers D, Davis RL, Kiger JA, Jr. 1981. Defect in cyclic AMP phosphodiesterase due to the dunce mutation of learning in *Drosophila melanogaster*. *Nature* 289:79-81.
- Cahill L, McGaugh JL, Weinberger NM. 2001. The neurobiology of learning and memory: some reminders to remember. *Trends Neurosci* 24:578-581.
- Chang KT, Shi YJ, Min KT. 2003. The *Drosophila* homolog of Down's syndrome critical region 1 gene regulates learning: implications for mental retardation. *Proc Natl Acad Sci U S A* 100:15794-15799.
- Chang L, Karin M. 2001. Mammalian MAP kinase signalling cascades. *Nature* 410:37-40.
- Chaturvedi D, Poppleton HM, Stringfield T, Barbier A, Patel TB. 2006. Subcellular localization and biological actions of activated RSK1 are determined by its interactions with subunits of cyclic AMP-dependent protein kinase. *Mol Cell Biol* 26:4586-4600.
- Chen C, Tonegawa S. 1997. Molecular genetic analysis of synaptic plasticity, activity-dependent neural development, learning, and memory in the mammalian brain. *Annu Rev Neurosci* 20:157-184.
- Cheng Y, Endo K, Wu K, Rodan AR, Heberlein U, Davis RL. 2001. *Drosophila* fasciilinII is required for the formation of odor memories and for normal sensitivity to alcohol. *Cell* 105:757-768.
- Chiang A-S, Blum A, Barditch J, Chen Y-H, Chiu S-L, Regulski M, Armstrong JD, Tully T, Dubnau J. 2007. (Article Retraction) - radish Encodes a Phospholipase-A2 and Defines a Neural Circuit Involved in Anesthesia-Resistant Memory. *Current Biology* 17.

- 
- Chiang AS, Blum A, Barditch J, Chen YH, Chiu SL, Regulski M, Armstrong JD, Tully T, Dubnau J. 2004. (RETRACTED ARTICLE) radish encodes a phospholipase-A2 and defines a neural circuit involved in anesthesia-resistant memory. *Curr Biol* 14:263-272.
- Clark AS, Henderson LP. 2003. Behavioral and physiological responses to anabolic-androgenic steroids. *Neurosci Biobehav Rev* 27:413-436.
- Clinton LK, Billings LM, Green KN, Caccamo A, Ngo J, Oddo S, McGaugh JL, LaFerla FM. 2007. Age-dependent sexual dimorphism in cognition and stress response in the 3xTg-AD mice. *Neurobiol Dis* 28:76-82.
- Comas D, Petit F, Preat T. 2004. *Drosophila* long-term memory formation involves regulation of cathepsin activity. *Nature* 430:460-463.
- Connolly JB, Roberts IJ, Armstrong JD, Kaiser K, Forte M, Tully T, O'Kane CJ. 1996. Associative learning disrupted by impaired Gs signaling in *Drosophila* mushroom bodies. *Science* 274:2104-2107.
- Conrad CD, Galea LA, Kuroda Y, McEwen BS. 1996. Chronic stress impairs rat spatial memory on the Y maze, and this effect is blocked by tianeptine pretreatment. *Behav Neurosci* 110:1321-1334.
- Conrad CD, Jackson JL, Wieczorek L, Baran SE, Harman JS, Wright RL, Korol DL. 2004. Acute stress impairs spatial memory in male but not female rats: influence of estrous cycle. *Pharmacol Biochem Behav* 78:569-579.
- Dalla C, Edgecomb C, Whetstone AS, Shors TJ. 2007. Females do not Express Learned Helplessness like Males do. *Neuropsychopharmacology*.
- Davis RL. 1996. Physiology and biochemistry of *Drosophila* learning mutants. *Physiol Rev* 76:299-317.
- Davis RL. 2005. Olfactory memory formation in *Drosophila*: from molecular to systems neuroscience. *Annu Rev Neurosci* 28:275-302.

- Davis S, Laroche S. 2006. Mitogen-activated protein kinase/extracellular regulated kinase signalling and memory stabilization: a review. *Genes Brain Behav* 5 Suppl 2:61-72.
- de Belle JS, Heisenberg M. 1994. Associative odor learning in *Drosophila* abolished by chemical ablation of mushroom bodies. *Science* 263:692-695.
- de Belle JS, Heisenberg M. 1996. Expression of *Drosophila* mushroom body mutations in alternative genetic backgrounds: a case study of the mushroom body miniature gene (mbm). *Proc Natl Acad Sci U S A* 93:9875-9880.
- Dill M, Wolf R, Heisenberg M. 1995. Behavioral analysis of *Drosophila* landmark learning in the flight simulator. *Learn Mem* 2:152-160.
- Douville E, Downward J. 1997. EGF induced SOS phosphorylation in PC12 cells involves P90 RSK-2. *Oncogene* 15:373-383.
- Drier EA, Tello MK, Cowan M, Wu P, Blace N, Sacktor TC, Yin JC. 2002. Memory enhancement and formation by atypical PKM activity in *Drosophila melanogaster*. *Nat Neurosci* 5:316-324.
- Dubnau J, Chiang AS, Grady L, Barditch J, Gossweiler S, McNeil J, Smith P, Buldoc F, Scott R, Certa U, Broger C, Tully T. 2003. The staufen/pumilio Pathway Is Involved in *Drosophila* Long-Term Memory. *Curr Biol* 13:286-296.
- Dubnau J, Chiang AS, Tully T. 2003. Neural substrates of memory: From synapse to system. *J Neurobiol* 54:238-253.
- Dubnau J, Grady L, Kitamoto T, Tully T. 2001. Disruption of neurotransmission in *Drosophila* mushroom body blocks retrieval but not acquisition of memory. *Nature* 411:476-480.
- Dudai Y. 1988. Neurogenetic dissection of learning and short-term memory in *Drosophila*. *Annu Rev Neurosci* 11:537-563.
- Dudai Y, Jan YN, Byers D, Quinn WG, Benzer S. 1976. *dunce*, a mutant of *Drosophila* deficient in learning. *Proc Natl Acad Sci U S A* 73:1684-1688.

- 
- Duffy JB. 2002. GAL4 system in *Drosophila*: a fly geneticist's Swiss army knife. *Genesis* 34:1-15.
- Egeland JA, Hostetter AM. 1983. Amish Study, I: Affective disorders among the Amish, 1976-1980. *Am J Psychiatry* 140:56-61.
- Eisenstein EM, Carlson AD. 1997. A comparative approach to the behavior called "learned helplessness". *Behav Brain Res* 86:149-160.
- Erber J. 1976. Retrograde amnesia in honeybees (*Apis mellifera carnica*). *J Comp Physiol Psychol* 90:41-46.
- Erikson E, Maller JL. 1985. A protein kinase from *Xenopus* eggs specific for ribosomal protein S6. *Proc Natl Acad Sci U S A* 82:742-746.
- Erikson RL. 1991. Structure, expression, and regulation of protein kinases involved in the phosphorylation of ribosomal protein S6. *J Biol Chem* 266:6007-6010.
- Finkbeiner S, Greenberg ME. 1996. Ca(2+)-dependent routes to Ras: mechanisms for neuronal survival, differentiation, and plasticity? *Neuron* 16:233-236.
- Folkers E, Drain P, Quinn WG. 1993. Radish, a *Drosophila* mutant deficient in consolidated memory. *Proc Natl Acad Sci U S A* 90:8123-8127.
- Folkers E, Waddell S, Quinn WG. 2006. The *Drosophila* radish gene encodes a protein required for anesthesia-resistant memory. *Proceedings of the National Academy of Sciences* 103:17496-17500.
- Friedrich MJ. 2000. Research with *Drosophila* provides clues to enhancing human memory. *Jama* 284:2857-2858.
- Frodin M, Gammeltoft S. 1999. Role and regulation of 90 kDa ribosomal S6 kinase (RSK) in signal transduction. *Mol Cell Endocrinol* 151:65-77.
- Geanacopoulos M. 2005. An introduction to RNA-mediated gene silencing. *Sci Prog* 88:49-69.



- Gerber B, Tanimoto H, Heisenberg M. 2004. An engram found? Evaluating the evidence from fruit flies. *Curr Opin Neurobiol* 14:737-744.
- Giniger E, Varnum SM, Ptashne M. 1985. Specific DNA binding of GAL4, a positive regulatory protein of yeast. *Cell* 40:767-774.
- Gormezano I, Tait RW. 1976. The Pavlovian analysis of instrumental conditioning. *Pavlov J Biol Sci* 11:37-55.
- Greenspan RJ, Ferveur JF. 2000. Courtship in *Drosophila*. *Annu Rev Genet* 34:205-232.
- Grewal SS, York RD, Stork PJ. 1999. Extracellular-signal-regulated kinase signalling in neurons. *Curr Opin Neurobiol* 9:544-553.
- Grotewiel MS, Beck CD, Wu KH, Zhu XR, Davis RL. 1998. Integrin-mediated short-term memory in *Drosophila*. *Nature* 391:455-460.
- Guo A, Li L, Xia SZ, Feng CH, Wolf R, Heisenberg M. 1996. Conditioned visual flight orientation in *Drosophila*: dependence on age, practice, and diet. *Learn Mem* 3:49-59.
- Han PL, Levin LR, Reed RR, Davis RL. 1992. Preferential expression of the *Drosophila rutabaga* gene in mushroom bodies, neural centers for learning in insects. *Neuron* 9:619-627.
- Hauge C, Frodin M. 2006. RSK and MSK in MAP kinase signalling. *J Cell Sci* 119:3021-3023.
- Heisenberg M. 1980. Mutants of brain structure and function: what is the significance of the mushroom bodies for behavior? *Basic Life Sci* 16:373-390.
- Heisenberg M. 1998. What do the mushroom bodies do for the insect brain? an introduction. *Learn Mem* 5:1-10.
- Heisenberg M. 2003. Mushroom body memoir: from maps to models. *Nat Rev Neurosci* 4:266-275.

- 
- Heisenberg M, Borst A, Wagner S, Byers D. 1985. *Drosophila* mushroom body mutants are deficient in olfactory learning. *J Neurogenet* 2:1-30.
- Heninger GR. 1997. Serotonin, sex, and psychiatric illness. *Proc Natl Acad Sci U S A* 94:4823-4824.
- Holden C. 2005. Sex and the suffering brain. *Science* 308:1574.
- Houslay MD. 2006. A RSK(y) relationship with promiscuous PKA. *Sci STKE* 2006:pe32.
- Impey S, Obrietan K, Storm DR. 1999. Making new connections: role of ERK/MAP kinase signaling in neuronal plasticity. *Neuron* 23:11-14.
- Ito K, Suzuki K, Estes P, Ramaswami M, Yamamoto D, Strausfeld NJ. 1998. The organization of extrinsic neurons and their implications in the functional roles of the mushroom bodies in *Drosophila melanogaster* Meigen. *Learn Mem* 5:52-77.
- Jackson RL, Maier SF, Coon DJ. 1979. Long-term analgesic effects of inescapable shock and learned helplessness. *Science* 206:91-93.
- Jaffe K, Baklien A, Zabala NA, Ferrer AC, Granier M, Tablante A, Ribbi-Jaffe A, Blau S. 1990. Amino acids and memory consolidation in the cricket. I: Changes in the titer of free amino acids in nervous tissue after learning. *Pharmacol Biochem Behav* 35:127-131.
- Jenkins JA, Williams P, Kramer GL, Davis LL, Petty F. 2001. The influence of gender and the estrous cycle on learned helplessness in the rat. *Biol Psychol* 58:147-158.
- Johannessen M, Delghandi MP, Moens U. 2004. What turns CREB on? *Cellular Signalling* 16:1211-1227.
- Jones SW, Erikson E, Blenis J, Maller JL, Erikson RL. 1988. A *Xenopus* ribosomal protein S6 kinase has two apparent kinase domains that are each similar to distinct protein kinases. *Proc Natl Acad Sci U S A* 85:3377-3381.

- 
- Kandel E, Abel T. 1995. Neuropeptides, adenylyl cyclase, and memory storage. *Science* 268:825-826.
- Kessler RC. 2003. Epidemiology of women and depression. *J Affect Disord* 74:5-13.
- Kim JJ, Diamond DM. 2002. The stressed hippocampus, synaptic plasticity and lost memories. *Nat Rev Neurosci* 3:453-462.
- Klemenz R, Weber U, Gehring WJ. 1987. The white gene as a marker in a new P-element vector for gene transfer in *Drosophila*. *Nucleic Acids Res* 15:3947-3959.
- Kreidl A. 1895. Ueber die Perception der Schallwellen bei den Fischen . *Archiv für die gesammte Physiologie des Menschen und der Thiere (Pflügers Archiv)* 61:450-464.
- Laughon A, Driscoll R, Wills N, Gesteland RF. 1984. Identification of two proteins encoded by the *Saccharomyces cerevisiae* GAL4 gene. *Mol Cell Biol* 4:268-275.
- Lechner HA, Byrne JH. 1998. New perspectives on classical conditioning: a synthesis of Hebbian and non-Hebbian mechanisms. *Neuron* 20:355-358.
- Lee T, Lee A, Luo L. 1999. Development of the *Drosophila* mushroom bodies: sequential generation of three distinct types of neurons from a neuroblast. *Development* 126:4065-4076.
- Leighton IA, Dalby KN, Caudwell FB, Cohen PT, Cohen P. 1995. Comparison of the specificities of p70 S6 kinase and MAPKAP kinase-1 identifies a relatively specific substrate for p70 S6 kinase: the N-terminal kinase domain of MAPKAP kinase-1 is essential for peptide phosphorylation. *FEBS Lett* 375:289-293.
- Levin LR, Han PL, Hwang PM, Feinstein PG, Davis RL, Reed RR. 1992. The *Drosophila* learning and memory gene *rutabaga* encodes a Ca<sup>2+</sup>/Calmodulin-responsive adenylyl cyclase. *Cell* 68:479-489.
- Liu L, Wolf R, Ernst R, Heisenberg M. 1999. Context generalization in *Drosophila* visual learning requires the mushroom bodies. *Nature* 400:753-756.

- Livingstone MS, Sziber PP, Quinn WG. 1984. Loss of calcium/calmodulin responsiveness in adenylate cyclase of rutabaga, a *Drosophila* learning mutant. *Cell* 37:205-215.
- Logan CA. 2002. When scientific knowledge becomes scientific discovery: The disappearance of classical conditioning before Pavlov. *J Hist Behav Sci* 38:393-403.
- Lukowiak K, Ringseis E, Spencer G, Wildering W, Syed N. 1996. Operant conditioning of aerial respiratory behaviour in *Lymnaea stagnalis*. *J Exp Biol* 199:683-691.
- Mackeigan JP, Murphy LO, Dimitri CA, Blenis J. 2005. Graded mitogen-activated protein kinase activity precedes switch-like c-Fos induction in mammalian cells. *Mol Cell Biol* 25:4676-4682.
- Margulies C, Tully T, Dubnau J. 2005. Deconstructing memory in *Drosophila*. *Curr Biol* 15:R700-713.
- Mašek P. 2005. Odor Intensity Learning in *Drosophila*. In: Würzburg: Bayerische Julius-Maximilians-Universität Würzburg.
- Matheson K, Anisman H. 2003. Systems of coping associated with dysphoria, anxiety and depressive illness: a multivariate profile perspective. *Stress* 6:223-234.
- Mazzucchelli C, Brambilla R. 2000. Ras-related and MAPK signalling in neuronal plasticity and memory formation. *Cell Mol Life Sci* 57:604-611.
- McGuire SE, Le PT, Davis RL. 2001. The role of *Drosophila* mushroom body signaling in olfactory memory. *Science* 293:1330-1333.
- Miller RR, Matzel LD. 2000. Memory involves far more than 'consolidation'. *Nat Rev Neurosci* 1:214-216.
- Miller WR, Seligman ME, Kurlander HM. 1975. Learned helplessness, depression, and anxiety. *J Nerv Ment Dis* 161:347-357.
- Mittelstaedt H, Mittelstaedt M-L. 1973. Mechanismen der Orientierung ohne richtende Außenreize. *Fortschritte der Zoologie* 21:46-58.

- Mizunami M, Iwasaki M, Okada R, Nishikawa M. 1998. Topography of modular subunits in the mushroom bodies of the cockroach. *J Comp Neurol* 399:153-161.
- Mohamed HA, Yao W, Fioravante D, Smolen PD, Byrne JH. 2005. cAMP-response Elements in *Aplysia* creb1, creb2, and Ap-uch Promoters: IMPLICATIONS FOR FEEDBACK LOOPS MODULATING LONG TERM MEMORY. *J. Biol. Chem.* 280:27035-27043.
- Monleon S, Vinader-Caerols C, Arenas MC, Parra A. 2007. Antidepressant drugs and memory: Insights from animal studies. *Eur Neuropsychopharmacol.*
- Mozzachiodi R, Lechner HA, Baxter DA, Byrne JH. 2003. In vitro analog of classical conditioning of feeding behavior in *aplysia*. *Learn Mem* 10:478-494.
- Murphy LO, Blenis J. 2006. MAPK signal specificity: the right place at the right time. *Trends Biochem Sci* 31:268-275.
- Nader K. 2003. Memory traces unbound. *Trends Neurosci* 26:65-72.
- Nash SM, Martinez SL, Dudeck MM, Davis SF. 1983. Learned helplessness in goldfish under conditions of low shock intensity. *J Gen Psychol* 108:97-101.
- Nighorn A, Healy MJ, Davis RL. 1991. The cyclic AMP phosphodiesterase encoded by the *Drosophila dunce* gene is concentrated in the mushroom body neuropil. *Neuron* 6:455-467.
- Nolen-Hoeksema S. 1987. Sex differences in unipolar depression: evidence and theory. *Psychol Bull* 101:259-282.
- Nolen-Hoeksema S. 1991. Responses to depression and their effects on the duration of depressive episodes. *J Abnorm Psychol* 100:569-582.
- Orton RJ, Sturm OE, Vyshemirsky V, Calder M, Gilbert DR, Kolch W. 2005. Computational modelling of the receptor-tyrosine-kinase-activated MAPK pathway. *Biochem J* 392:249-261.

- Overmier JB, Seligman ME. 1967. Effects of inescapable shock upon subsequent escape and avoidance responding. *J Comp Physiol Psychol* 63:28-33.
- Park CR, Campbell AM, Diamond DM. 2001. Chronic psychosocial stress impairs learning and memory and increases sensitivity to yohimbine in adult rats. *Biol Psychiatry* 50:994-1004.
- Pavlov IP. 1927. *Conditioned reflexes: an investigation of the physiological activity of the cerebral cortex*. New York.
- Perazzona B, Isabel G, Preat T, Davis RL. 2004. The role of cAMP response element-binding protein in *Drosophila* long-term memory. *J Neurosci* 24:8823-8828.
- Peter A, Schottler P, Werner M, Beinert N, Dowe G, Burkert P, Mourkioti F, Dentzer L, He Y, Deak P, Benos PV, Gatt MK, Murphy L, Harris D, Barrell B, Ferraz C, Vidal S, Brun C, Demaille J, Cadieu E, Dreano S, Gloux S, Lelaure V, Mottier S, Galibert F, Borkova D, Minana B, Kafatos FC, Bolshakov S, Siden-Kiamos I, Papagiannakis G, Spanos L, Louis C, Madueno E, de Pablos B, Modolell J, Bucheton A, Callister D, Campbell L, Henderson NS, McMillan PJ, Salles C, Tait E, Valenti P, Saunders RD, Billaud A, Pachter L, Klapper R, Janning W, Glover DM, Ashburner M, Bellen HJ, Jackle H, Schafer U. 2002. Mapping and identification of essential gene functions on the X chromosome of *Drosophila*. *EMBO Rep* 3:34-38.
- Presente A, Boyles RS, Serway CN, de Belle JS, Andres AJ. 2004. Notch is required for long-term memory in *Drosophila*. *Proc Natl Acad Sci U S A* 101:1764-1768.
- Putz G. 2002. Characterization of memories and ignorant (S6KII) mutants in operant conditioning in the heat-box. In: Julius-Maximilians-Universität Würzburg, Germany.
- Putz G, Bertolucci F, Raabe T, Zars T, Heisenberg M. 2004. The S6KII (rsk) Gene of *Drosophila melanogaster* Differentially Affects an Operant and a Classical Learning Task. *J Neurosci* 24:9745-9751.
- Putz G, Heisenberg M. 2002. Memories in *Drosophila* Heat-box Learning. *Learn Mem* 9:349-359.

- Quinn WG, Harris WA, Benzer S. 1974. Conditioned behavior in *Drosophila melanogaster*. *Proc Natl Acad Sci U S A* 71:708-712.
- Renard GM, Suarez MM, Levin GM, Rivarola MA. 2005. Sex differences in rats: effects of chronic stress on sympathetic system and anxiety. *Physiol Behav* 85:363-369.
- Rescorla RA, Solomon RL. 1967. Two-process learning theory: Relationships between Pavlovian conditioning and instrumental learning. *Psychol Rev* 74:151-182.
- Richards SA, Dreisbach VC, Murphy LO, Blenis J. 2001. Characterization of regulatory events associated with membrane targeting of p90 ribosomal S6 kinase 1. *Mol Cell Biol* 21:7470-7480.
- Rivier C. 1999. Gender, sex steroids, corticotropin-releasing factor, nitric oxide, and the HPA response to stress. *Pharmacol Biochem Behav* 64:739-751.
- Robertson HM, Preston CR, Phillis RW, Johnson-Schlitz DM, Benz WK, Engels WR. 1988. A stable genomic source of P element transposase in *Drosophila melanogaster*. *Genetics* 118:461-470.
- Roux PP, Richards SA, Blenis J. 2003. Phosphorylation of p90 Ribosomal S6 Kinase (RSK) Regulates Extracellular Signal-Regulated Kinase Docking and RSK Activity. *Mol Cell Biol* 23:4796-4804.
- Sayeed O, Benzer S. 1996. Behavioral genetics of thermosensation and hygrosensation in *Drosophila*. *PNAS* 93:6079-6084.
- Schwab MS, Roberts BT, Gross SD, Tunquist BJ, Taieb FE, Lewellyn AL, Maller JL. 2001. Bub1 is activated by the protein kinase p90(Rsk) during *Xenopus* oocyte maturation. *Curr Biol* 11:141-150.
- Schwaerzel M, Heisenberg M, Zars T. 2002. Extinction antagonizes olfactory memory at the subcellular level. *Neuron* 35:951.

- Schwaerzel M, Monastirioti M, Scholz H, Friggi-Grelin F, Birman S, Heisenberg M. 2003. Dopamine and octopamine differentiate between aversive and appetitive olfactory memories in *Drosophila*. *J Neurosci* 23:10495-10502.
- Seligman ME, Maier SF. 1967. Failure to escape traumatic shock. *J Exp Psychol* 74:1-9.
- Servillo G, Della Fazio MA, Sassone-Corsi P. 2002. Coupling cAMP Signaling to Transcription in the Liver: Pivotal Role of CREB and CREM. *Experimental Cell Research* 275:143-154.
- Seward JP, Humphrey GL. 1967. Avoidance learning as a function of pretraining in the cat. *J Comp Physiol Psychol* 63:338-341.
- Sherman AD, Petty F. 1980. Neurochemical basis of the action of antidepressants on learned helplessness. *Behav Neural Biol* 30:119-134.
- Shors TJ. 2004. Learning During Stressful Times. *Learn. Mem.* 11:137-144.
- Silva AJ, Kogan JH, Frankland PW, Kida S. 1998. CREB and memory. *Annu Rev Neurosci* 21:127-148.
- Skinner BF. 1950. Are theories of learning necessary? *Psychol Rev* 57:193-216.
- Skoulakis EM, Davis RL. 1996. Olfactory learning deficits in mutants for *leonardo*, a *Drosophila* gene encoding a 14-3-3 protein. *Neuron* 17:931-944.
- Skoulakis EM, Kalderon D, Davis RL. 1993. Preferential expression in mushroom bodies of the catalytic subunit of protein kinase A and its role in learning and memory. *Neuron* 11:197-208.
- Slater MR, Craig EA. 1987. Transcriptional regulation of an *hsp70* heat shock gene in the yeast *Saccharomyces cerevisiae*. *Mol Cell Biol* 7:1906-1916.
- Steiner M, Streiner DL, Steinberg S, Stewart D, Carter D, Berger C, Reid R, Grover D. 1999. The measurement of premenstrual mood symptoms. *J Affect Disord* 53:269-273.



- Steiner M, Yatham LN, Coote M, Wilkins A, Lepage P. 1999. Serotonergic dysfunction in women with pure premenstrual dysphoric disorder: is the fenfluramine challenge test still relevant? *Psychiatry Res* 87:107-115.
- Strausfeld NJ, Li Y. 1999. Organization of olfactory and multimodal afferent neurons supplying the calyx and pedunculus of the cockroach mushroom bodies. *J Comp Neurol* 409:603-625.
- Strausfeld NJ, Li Y. 1999. Representation of the calyces in the medial and vertical lobes of cockroach mushroom bodies. *J Comp Neurol* 409:626-646.
- Strausfeld NJ, Sinakevitch I, Vilinsky I. 2003. The mushroom bodies of *Drosophila melanogaster*: an immunocytological and golgi study of Kenyon cell organization in the calyces and lobes. *Microsc Res Tech* 62:151-169.
- Takamori K, Yoshida S, Okuyama S. 2001. Availability of learned helplessness test as a model of depression compared to a forced swimming test in rats. *Pharmacology* 63:147-153.
- Taylor SS, Buechler JA, Yonemoto W. 1990. cAMP-dependent protein kinase: framework for a diverse family of regulatory enzymes. *Annu Rev Biochem* 59:971-1005.
- Technau G, Heisenberg M. 1982. Neural reorganization during metamorphosis of the corpora pedunculata in *Drosophila melanogaster*. *Nature* 295:405-407.
- Thompson RF. 1986. The neurobiology of learning and memory. *Science* 233:941-947.
- Thorndike E. 1898. Some Experiments on Animal Intelligence. *Science* 7:818-824.
- Trevor R, Norman CM. 2000. Stress induced animal models of depression. *Stress Medicine* 16:195-197.
- Tully T. 1984. *Drosophila* learning: behavior and biochemistry. *Behav Genet* 14:527-557.
- Tully T, Bourchouladze R, Scott R, Tallman J. 2003. Targeting the CREB pathway for memory enhancers. *Nat Rev Drug Discov* 2:267-277.

- Tully T, Quinn WG. 1985. Classical conditioning and retention in normal and mutant *Drosophila melanogaster*. *J Comp Physiol [A]* 157:263-277.
- Turner EH, Loftis JM, Blackwell AD. 2006. Serotonin a la carte: Supplementation with the serotonin precursor 5-hydroxytryptophan. *Pharmacology & Therapeutics* 109:325-338.
- Verplanck WS. 1956. The operant conditioning of human motor behavior. *Psychol Bull* 53:70-83.
- Waddell S, Quinn WG. 2001. What can we teach *Drosophila*? What can they teach us? *Trends Genet* 17:719-726.
- Waltereit R, Weller M. 2003. Signaling from cAMP/PKA to MAPK and synaptic plasticity. *Mol Neurobiol* 27:99-106.
- Wang Y, Chiang AS, Xia S, Kitamoto T, Tully T, Zhong Y. 2003. Blockade of neurotransmission in *Drosophila* mushroom bodies impairs odor attraction, but not repulsion. *Curr Biol* 13:1900-1904.
- Wassarman DA, Solomon NM, Rubin GM. 1994. The *Drosophila melanogaster* ribosomal S6 kinase II-encoding sequence. *Gene* 144:309-310.
- Wasserman EA, Miller RR. 1997. What's elementary about associative learning? *Annu Rev Psychol* 48:573-607.
- Wasylyk B, Hagman J, Gutierrez-Hartmann A. 1998. Ets transcription factors: nuclear effectors of the Ras-MAP-kinase signaling pathway. *Trends Biochem Sci* 23:213-216.
- Willner P. 1984. Cognitive functioning in depression: a review of theory and research. *Psychol Med* 14:807-823.
- Willner P. 1991. Animal models as simulations of depression. *Trends Pharmacol Sci* 12:131-136.

- Wolf R, Heisenberg M. 1990. Visual control of straight flight in *Drosophila melanogaster*. *J Comp Physiol [A]* 167:269-283.
- Wolf R, Heisenberg M. 1991. Basic organization of operant behavior as revealed in *Drosophila* flight orientation. *J Comp Physiol [A]* 169:699-705.
- Wolf R, Wittig T, Liu L, Wustmann G, Eyding D, Heisenberg M. 1998. *Drosophila* mushroom bodies are dispensable for visual, tactile, and motor learning. *Learn Mem* 5:166-178.
- Wustmann G, Heisenberg M. 1997. Behavioral manipulation of retrieval in a spatial memory task for *Drosophila melanogaster*. *Learn Mem* 4:328-336.
- Wustmann G, Rein K, Wolf R, Heisenberg M. 1996. A new paradigm for operant conditioning of *Drosophila melanogaster*. *J Comp Physiol [A]* 179:429-436.
- Yang MY, Armstrong JD, Vilinsky I, Strausfeld NJ, Kaiser K. 1995. Subdivision of the *Drosophila* mushroom bodies by enhancer-trap expression patterns. *Neuron* 15:45-54.
- Yao KM, Samson ML, Reeves R, White K. 1993. Gene *elav* of *Drosophila melanogaster*: a prototype for neuronal-specific RNA binding protein gene family that is conserved in flies and humans. *J Neurobiol* 24:723-739.
- Yin JC, Del Vecchio M, Zhou H, Tully T. 1995. CREB as a memory modulator: induced expression of a dCREB2 activator isoform enhances long-term memory in *Drosophila*. *Cell* 81:107-115.
- Yin JC, Wallach JS, Del Vecchio M, Wilder EL, Zhou H, Quinn WG, Tully T. 1994. Induction of a dominant negative CREB transgene specifically blocks long-term memory in *Drosophila*. *Cell* 79:49-58.
- Yuan Q, Lin F, Zheng X, Sehgal A. 2005. Serotonin Modulates Circadian Entrainment in *Drosophila*. *Neuron* 47:115-127.

- Zars M, Zars T. 2006. High and low temperatures have unequal reinforcing properties in *Drosophila* spatial learning. *Journal of Comparative Physiology A: Sensory, Neural, and Behavioral Physiology*:1-9.
- Zars T, Fischer M, Schulz R, Heisenberg M. 2000. Localization of a Short-Term Memory in *Drosophila*. *Science* 288:672-675.
- Zars T, Wolf R, Davis R, Heisenberg M. 2000. Tissue-specific expression of a type I adenylyl cyclase rescues the *rutabaga* mutant memory defect: in search of the engram. *Learn Mem* 7:18-31.

## 9 Curriculum vitae

Personal details			
Name	Bertolucci Franco		
Nationality	Italian		
Date and place of Birth	14 June 1975, Vicenza (Italy)		
Marital status	Married, two children		
Course of studies			
2003 – 2008	PhD student in the lab of Prof. Martin Heisenberg, Department of Genetics and Neurobiology, University of Würzburg, Germany.		
2002	University of Padova, Department of Biology, Padova – Italy (defense of Diploma thesis) Title: Characterization of learning and memory in <i>Drosophila</i> S6KII (ignorant) mutants in Classical Conditioning		
2001 – 2002	Julius-Maximilian's-University Würzburg – Germany (Diploma)		
2001	Albert-Ludwig's-University Freiburg – Germany as Stipendiary		
2000 – 2001	Julius-Maximilian-University Würzburg – Germany as Stipendiary		
1999 – 2000	University of Padova, Department of Biology, Padova – Italy		
1998 – 1999	University Bayreuth – Germany, Erasmus Project Stipendiary		
1994 – 1998	University of Padova, Department of Biology, Padova – Italy		
1989 – 1994	Scientific High School Paolo Liroy, Vicenza – Italy		
Work experience			
Period	Between 2001 and 2007		
Position	Laboratory assistant and controller of several practical courses in:		
Name and Address of employers	Plant Physiology (2001)	Genetics (2001) and Neurobiology (2004, 2006 and 2007)	Molecular Biology (2002)
	Prof. Dr. Werner Kaiser Julius-von-Sachs-Institute Dep. Of Botany I Julius-von-Sachs-Platz 2 D-97082 Würzburg	Prof. Dr. Martin Heisenberg Dep. Of Genetics and Neurobiology Biozentrum - Am Hubland D-97074 Würzburg	Prof. Dr. Erich Buchner Dep. Of Genetics and Neurobiology Biozentrum - Am Hubland D-97074 Würzburg
Publications			
Putz, G., Bertolucci, F., Raabe, T., Zars, T., and Heisenberg, M. (2004). The S6KII (rsk) Gene of <i>Drosophila melanogaster</i> Differentially Affects an Operant and a Classical Learning Task. <i>Journal of Neuroscience</i> 24, 9745-9751.			
Bertolucci, F. and Heisenberg, M. (2008). Effects of antidepressants on learned helplessness in <i>Drosophila melanogaster</i> . In preparation			

## 10 Acknowledgements

Most of all I would like to thank my wife Silvie, for being like she is, for the precious and steady support that she gave me and the immense patience she showed throughout all these years. Thanks also to Nicola and Matteo for putting my life upside down in the most beautiful and joyful way only they could do.

A special thank goes to my parents which were always there to help me. The long distance between us did not stop them from concretely showing me their support and that made it even more significant.

And then, last but not least, I would like to express the deepest gratitude to the family at the department of Genetics and Neurobiology. Especially Prof. Martin Heisenberg for being a constant reference point and for the freedom he gave me during all these years.

I thank the greatest TAs I ever met, Eva and Ewa, precious friends and irreplaceable helpers. Andreas, for his pivotal role in the software development. Hans and Konrad for their always friendly and competent technical support. Prof. David Anderson for the inspiring discussion which focused my interest on learned helplessness. The students from the practical courses which shared with me the gratification and the frustration of working with the heat-box. All the colleagues which contributed to the positive and stimulating atmosphere in the laboratory: Jens (-olino), Pavel (Pipovitsch), Dhananjay (Angelino), Markus (Markus), Viera, Simon, Dieter, Franz, Isabell, Arnim, Johannes, Dan, Wolfgang, Eric, Henrike, Anne, Bertram, Jessica, Burkhard, Dushyant, Ayse, Tulip, Margarete, Reinhard and the rest of the party from the Heisenberg's and Buchner's groups. Thanks also to my fat carnivore plants which helped me to keeping my room "almost" flies-free.